

Designed for traumatology and arthroplasty

# Trauma Recon System (TRS) Battery-driven Power System

Instructions for Use





# Table of Contents

---

|                     |                                    |   |
|---------------------|------------------------------------|---|
| <b>Introduction</b> | General Information                | 3 |
|                     | Explanation of Symbols Used        | 6 |
|                     | General Information on Power Tools | 7 |
|                     | Starting the System                | 8 |

---

|                            |                                              |    |
|----------------------------|----------------------------------------------|----|
| <b>TRS Battery Modular</b> | Power Tool                                   | 16 |
|                            | Functions of the Lid for TRS Battery Modular | 18 |
|                            | Attachments for TRS Battery Modular          | 20 |

---

|                               |                                                 |    |
|-------------------------------|-------------------------------------------------|----|
| <b>TRS Recon Sagittal Saw</b> | Power Tool                                      | 34 |
|                               | Functions of the Lid for TRS Recon Sagittal Saw | 36 |
|                               | Working with the TRS Recon Sagittal Saw         | 37 |

---

|                             |                                                                           |    |
|-----------------------------|---------------------------------------------------------------------------|----|
| <b>Care and Maintenance</b> | General Information                                                       | 39 |
|                             | Preparation prior to Cleaning                                             | 40 |
|                             | a) Manual Cleaning Instruction                                            | 41 |
|                             | b) Mechanical /Automated Cleaning Instruction<br>with Manual Pre-cleaning | 45 |
|                             | Maintenance and Lubrication                                               | 50 |
|                             | Inspection and Function Test                                              | 52 |
|                             | Packaging, Sterilization and Storage                                      | 53 |
|                             | Repairs and Technical Service                                             | 54 |
|                             | Disposal                                                                  | 55 |

---

---

|                             |                               |    |
|-----------------------------|-------------------------------|----|
| <b>Troubleshooting</b>      | Handpiece and Lid             | 56 |
|                             | Power Module                  | 59 |
|                             | Attachments and Cutting Tools | 60 |
| <hr/>                       |                               |    |
| <b>Technical Data</b>       | Duty Cycle                    | 62 |
|                             | Machine Specifications        | 63 |
|                             | Environmental Conditions      | 64 |
|                             | Applicable Standards          | 65 |
|                             | Electromagnetic Compatibility | 68 |
| <hr/>                       |                               |    |
| <b>Ordering Information</b> |                               | 72 |

## General Information

---

### Intended use

The Trauma Recon System (TRS) is a battery-driven power tool system intended for use during general orthopedic procedures to drill, saw and ream hard tissue or bone and soft tissue.

### Safety instructions

The surgeon has to evaluate if the machine is suitable for an application, based on power limitation of the machine, attachment and cutting tool regarding bone strength/ anatomical situation as well as handling of the machine, attachment and cutting tool regarding bone size.

In addition, the contraindications of the implant have to be respected. Please refer to the corresponding "Surgical Techniques" of the implant system used.

The Trauma Recon System is only to be used for patient treatment after careful consultation of the instructions for use. It is recommended that an alternative system is available to use during application, as technical problems can never be completely ruled out.

The Trauma Recon System is designed for use by physicians and trained medical personnel.

DO NOT use any apparently damaged components.

DO NOT use any component if the packaging is damaged.

DO NOT use this equipment in presence of oxygen, nitrous oxide or a mixture consisting of flammable anesthetic and air.

To ensure proper operation of the tool, use only Synthes original accessories.

Before the first and every subsequent use, power tools and their accessories/attachments except the Power Module have to run through the complete reprocessing procedure. Protective covers and foils must be fully removed before sterilization.

For the tool to function properly, Synthes recommends that it is cleaned and serviced after each use in accordance with the process recommended in the chapter "Care and Maintenance". Compliance with these specifications can considerably extend the service life of the tool. Only use Synthes oil (519.970) to lubricate the tool.

Efficiently working cutting tools are the basis for successful surgery. Therefore, it is mandatory to check used cutting tools after every use for wear and/or damage and to replace them if necessary. We recommend using new Synthes cutting tools for every surgery.

Cutting tools must be cooled with irrigation liquid to prevent heat necrosis.

The user of the product is responsible for proper use of the equipment during surgery.

If the Trauma Recon System is used in conjunction with an implant system please consult the corresponding "Technique Guide".

For important information regarding electromagnetic compatibility (EMC) please refer to the chapter "Electromagnetic Compatibility" in this manual.

The tool is classified as type BF against electrical shock and leakage current. The tool is suitable for use on patients in accordance with IEC 60601-1.

### Unusual Transmissible Pathogens

Surgical patients identified as at-risk for Creutzfeldt-Jakob disease (CJD) and related infections should be treated with single-use instruments. Dispose of instruments used or suspected of use on a patient with CJD after surgery and/or follow current national recommendations.

---

**Note:** To ensure proper operation of the tool, annual maintenance by a Synthes Service Center is necessary. The manufacturer shall assume no responsibility for damage resulting from improper operation, neglected or unauthorized maintenance of the tool.

---

**Precautions:**

- Always wear personal protective equipment (PPE) including safety goggles when handling the TRS system.
- To avoid injuries, the locking mechanism of the tool has to be activated before every manipulation and before placing the tool back down, i.e. the mode switch has to be in the LOCK position .
- The tool may only be operated with a fully charged power module. We recommend that the power module is replaced into the charger immediately after surgery.
- The power module must not be sterilized, washed, rinsed or dropped. This would destroy the power module with possible secondary damage.
- Only place the tool in an upright position when changing attachments or cutting tools during surgery. The handpiece must be laid on its side when not in use in order to avoid the risk of being dropped or contaminating other instruments.
- If the machine has been dropped it should be checked carefully for damage. In case that any damage is visible, do not use it anymore and send it to the Synthes Service Center.
- Never place the TRS into a magnetic environment since the machine might start unintentionally.
- If a product drops on the floor, fragments may split off. This represents a danger for the patient and user as:
  - These fragments may be sharp.
  - Unsterile fragments may enter the sterile field or hit the patient.
- Should the system have corroded parts, do not use it anymore and send it to the Synthes service center.

**Accessories/scope of delivery**

The Trauma Recon System consists of two handpieces with corresponding lids, one or several power modules (battery, motor and electronics) and a range of attachments designed for the TRS Battery Modular.

To charge the power module, please only use the corresponding Synthes Universal Battery Charger II (05.001.204).

For the system to operate properly only Synthes cutting tools should be used.

Special auxiliaries such as cleaning brushes and Synthes oil are available for cleaning and servicing the system. No oils from other manufacturers may be used. Only Synthes oil (519.970) may be used.

Lubricants with other compositions can cause jamming, can have a toxic effect or can have a negative impact on the sterilization results. Only lubricate the power tool and the attachments when clean.

Synthes recommends using specifically designed washing basket (68.001.606 with lid 68.001.602) to wash, sterilize and store the system.

The following components are essential to ensure proper operation:

| <b>Main system components</b> | <b>TRS Battery Modular</b> | <b>TRS Recon Sagittal Saw</b> |
|-------------------------------|----------------------------|-------------------------------|
| Battery Handpiece             | 05.001.201                 | 05.001.240                    |
| Lid for Battery Handpiece     | 05.001.231                 | 05.001.241                    |
| Power Module                  | 05.001.202                 | 05.001.202                    |
| Sterile Cover                 | 05.001.203                 | 05.001.203                    |
| Universal Battery Charger II  | 05.001.204                 | 05.001.204                    |
| Attachment option             | Yes                        | No                            |

Please refer to the end of these instructions for use for an overview of components for the system.

---

### **Storage and transport**

Please use the original packaging for dispatch and transport. If this is no longer available, please contact the Synthes office.

The same environmental conditions apply for transport as for storage, see page 62.

### **Servicing**

This system requires regular maintenance service, at least once a year, in order to maintain its functionality. This service has to be performed by the original manufacturer or an authorized site.

The manufacturer assumes no responsibility for damage resulting from improper operation, neglected or unauthorized maintenance of the tool.

### **Warranty/Liability**

The warranty for the tools and accessories does not cover damage of any kind resulting from wear, improper use, improper reprocessing and maintenance, damaged seal, use of non Synthes cutting tools and lubricants or improper storage and transport.

The manufacturer shall assume no liability for damage resulting from improper use, neglected or unauthorized maintenance or servicing of the tool.

Synthes warranty does not cover the function and results from using tools from other manufacturers.









For further information on the warranty, please contact your local Synthes office.









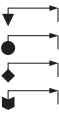

### **Locating of the instrument or fragments of instruments**

Synthes instruments are designed and manufactured to perform within the scope of their intended use. However, if a Power Tool or accessory/attachment breaks during use, a visual inspection or a medical image device (e.g. CT, Radiation Devices, etc.) can aid in locating the fragments and/or components of the instrument.

## Explanation of Symbols Used

The following symbols are applied to the device or individual components

|                                                                                    |                                                                                                                                                                                                                                    |
|------------------------------------------------------------------------------------|------------------------------------------------------------------------------------------------------------------------------------------------------------------------------------------------------------------------------------|
|    | Caution. Read the provided instructions for use before operating the device.                                                                                                                                                       |
|    | Read the provided instructions for use before operating the device.                                                                                                                                                                |
|    | Do not immerse device in liquids.                                                                                                                                                                                                  |
|    | The device is classified as type BF against electrical shock and leakage current. The device is suitable for use on patients according to the standards defined by IEC 60601-1                                                     |
|   | The European Battery Directive 2006/66/ EC applies to this device. See section "Disposal" on page 53. This device contains LithiumIon batteries that should be disposed of in accordance with environment protection requirements. |
|  | Product is UL Classified to the requirements of both the United States and Canada                                                                                                                                                  |
|  | The device meets the requirements of directive 93 /42/EEC for medical devices. It is authorized by an independent named site for which it bears the CE symbol.                                                                     |
|  | Non sterile                                                                                                                                                                                                                        |
|  | Do not use if package is damaged.                                                                                                                                                                                                  |

|                                                                                     |                                                           |
|-------------------------------------------------------------------------------------|-----------------------------------------------------------|
|    | Turn the lid in this direction for closing the handpiece. |
|    | Lid is unlocked and can be attached or removed.           |
|    | Locked symbol. Drive Unit is off for safety.              |
|    | Information button on the power module                    |
|   | Charge status display on power module                     |
|  | Service indicator on power module                         |
| S9                                                                                  | Duty cycle type according to IEC60034-1                   |
| IPX4                                                                                | Ingress protection rating according to IEC 60529          |
|  | Temperature                                               |
|  | Relative humidity                                         |
|  | Atmospheric pressure                                      |
|  | Manufacturer                                              |
|  | Date of manufacture                                       |





## General Information on Power Tools

### Handpiece (05.001.201/05.001.240)

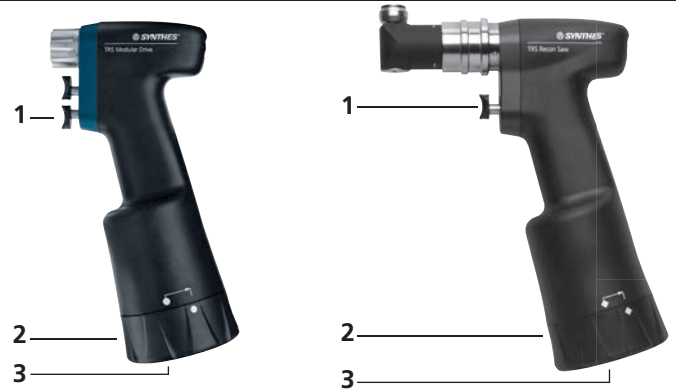
- 1 Trigger(s)
- 2 Lid
- 3 Mode switch (integrated onto lid)



### Lid (05.001.231/05.001.241)

- 4 UNLOCK position 
- 5 LOCK position 
- 6 Mode(s) for dedicated applications



### Power module (05.001.202)

- 1 Information button (when pressed, the charge status display and/or service indicator illuminate for a few seconds)
- 2 Charge status display
- 3 Service indicator (when LED illuminates the power module must immediately be sent to the nearest Synthes service center)
- 4 Lever to remove the power module from the handpiece



## Starting the System

### Inserting the power module

To ensure sterility, the power module is inserted into the sterile housing of the handpiece by two people, one of whom is wearing sterile garments:

1. The person wearing the sterile garments holds the open, sterile handpiece with the open side up (Fig. 1).
2. The person wearing the sterile garments places the sterile cover on the handpiece (Fig. 2) and checks if it is seated correctly. The sterile cover ensures that the unsterile power module does not contact the outside of the sterile handpiece.
3. The person not wearing sterile garments carefully guides the unsterile power module through the sterile cover into the handpiece (Fig. 3). Press firmly onto the power module to ensure that it is correctly seated in the handpiece (Fig. 4). During insertion ensure that the power module is properly aligned and that the person not wearing sterile garments does not touch the outside of the sterile handpiece.
4. The person not wearing sterile garments grasps the flanges on the sterile cover and removes it from the handpiece (Fig. 5).
5. The person wearing the sterile garments places the sterile lid on the handpiece (Fig. 6). It is essential to ensure that the sterile lid does not touch the unsterile power module. Ensure the correct alignment of the markings on the outside of the handpiece and the lid (Fig. 1 on the next page). Twist the lid clockwise to lock the handpiece (Fig. 2 on the next page) and check if the lid is seated correctly by gently pulling on it. Secure by turning the mode switch to LOCK  (Fig. 3 on the next page).
6. The desired mode can now be selected. Please find detailed information about the different modes in the chapters "TRS Battery Modular" and "TRS Recon Sagittal Saw".



Fig. 1



Fig. 2



Fig. 3



Fig. 4



Fig. 5



Fig. 6

---

**Precautions:**

- To avoid injuries, the locking mechanism of the tool has to be activated before every manipulation and before placing the tool back down, i.e. the mode switch has to be in the LOCK position.
  - Always check correct functioning before use on patient.
  - Always have a back-up system to prevent problems in case of deficient system.
  - Pay particular attention to all the instructions in the individual sections that are identified with “Precaution”.
  - The lid has to be properly attached to the handpiece. Therefore, step 5 on the previous page has to be carefully followed.
  - The tool should only be operated with a fully charged power module. We recommend that the power module is replaced into the charger immediately after surgery.
  - To ensure aseptic conditions the power module must not be removed from the handpiece until the end of surgery. The power module has enough battery capacity for the entire surgery.
  - Sterilize the sterile cover after each use to ensure aseptic conditions when inserting the unsterile power module into the sterile handpiece.
- 

**How to proceed if the power module is exposed to a light mechanical shock**

1. Check the power module for signs of mechanical damage, tears, etc. Damaged power modules must not be used and have to be sent to be repaired.
2. Press the information button briefly to check the state of charge and the service indicator. If the service indicator illuminates the power module may not be used and has to be sent in to be repaired.
3. Press the information button for approximately 7 seconds until the motor starts and the power module performs a self-test. If this is completed and the service indicator does not illuminate, the power module can be used. If the power module does not function properly after the self-test has been carried out, it needs to be sent in to be repaired.



Fig. 1



Fig. 2



Fig. 3

---

### Removing the power module

Simultaneously press the safety button of the mode switch and turn to UNLOCK  (Fig. 1). Turn the lid counterclockwise to open the handpiece and remove the lid. Then pull the power module using the lever (Fig. 2). Finally insert the power module back into the battery charger.

---

**Precaution:** The power tool has to be kept upright (Fig. 2) so that the Power Module does not drop to the floor.

---



Fig. 1



Fig. 2

---

### **Available battery capacity**

A fully charged power module has sufficient capacity to carry out long and complex surgeries without needing recharging.

The state of charge of the power module can be checked before inserting or after removing the power module from the handpiece

---

### **Precautions:**

- The tool must only be operated with a fully charged power module. We recommend that the power module is replaced into the charger immediately after surgery.
  - If in doubt press the information button before using the power module to check the state of charge.
  - Do not use a faulty power module (service indicator illuminates). It should be sent in to the nearest Synthes service center for servicing.
  - To ensure aseptic conditions, the power module must not be removed from the handpiece until the end of surgery.
- 

### **Power module overheat protection**

Generally, medical power tools can heat up if in constant use. The “cool down” times should be observed, cf. chapter “Duty Cycle” on page 60 to prevent from exceeding the acceptable surface temperature of the tool.

A safety system prevents defects of the battery and the motor by thermal overload:

- If the battery or the motor become too hot during use, initially the power is automatically cut and the speed is reduced. Although it is still possible to work with the tool, it is not recommended.
- In a second step, the tool automatically switches off and cannot be operated until the battery and the motor have cooled down.

### **Energy saving function**

If the tool with inserted power module is not used for approximately two hours the power module switches itself off automatically. It is only possible to continue working if the mode switch is first set to the LOCK position  and then back to the desired mode (DRILL/REAM, SAW, OSC DRILL).

## Charging, storing and using power modules

### Charging

Only use the Synthes Universal Battery Charger II (05.001.204) to charge the power module. Using a charger that does not originate from Synthes can damage the power module.

The power modules should always be charged before use.

Charge the power modules within an ambient temperature range of 10°C/50°F to max. 40°C/104°F.



Keep the charger and the power modules clean and in a cool and dry place.

Detailed information on the Universal Battery Charger II can be found in the Instructions for Use (036.000.500).



### Periodical Check and Calibration

To ensure that the Trauma Recon System (05.001.201, 05.001.240) can operate safely and reliably, the Trauma Recon System power module (05.001.202) has to be checked at periodical intervals. It will be indicated if the power module performance is sufficient or if the power module needs to be replaced.

The charger will indicate the necessity for recalibration, this will take around 4 hours. When it needs to be checked, the yellow display light  flashes (Fig. 1). The check needs to be carried out within the next 3 charging cycles.

This is done by pressing the exclamation mark button  for at least 2 seconds (Fig. 2). The yellow charger display  goes out and the display  changes from flashing to lighting up (Fig. 3). If the check is not carried out within the next 3 charging cycles, the device carries out the check automatically.

Completion of the process is indicated as follows:

- Green display light  : power module has been checked, charged and is ready to use.
- Red display light  : power module has been checked and found to be faulty, is not charged and cannot be used; the red service indicator lamp on the power module lights up. Send in the power module for servicing.

### Precautions:

- If the check is not carried out within the next 3 charging cycles, the charger starts this process automatically. The yellow display  lights up (Fig. 3).
- It takes around 4 hours to check the power module.

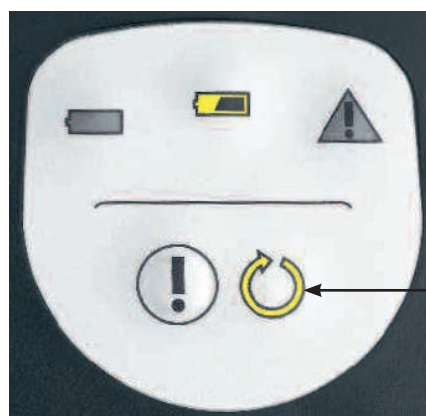

Fig. 1

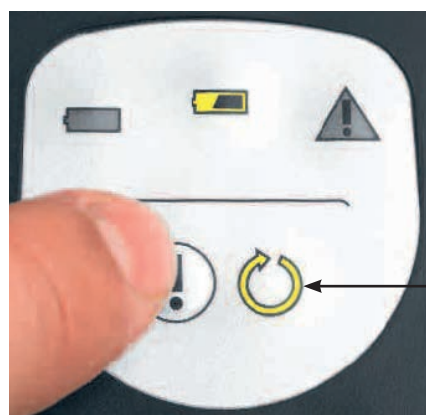

Fig. 2



Fig. 3

---

## Storage

Always recharge the power module (05.001.202) after each use. Do not store an empty power modules as this will shorten the life span and will not be covered by warranty.

When the power module is not in use, store it in the Synthes Universal Battery Charger II (05.001.204). This will ensure that it is always fully charged and ready to use.

Therefore the Universal Battery Charger II should always be turned on. Never expose the power module to temperatures over 55 °C for a maximum of 72 hours.

## Use

Do not remove the power module from its original packaging until required for use.

Do not drop or apply force to the power module. This will destroy it with possible secondary damage.

Only use the power module for its intended use. Do not use any power module which is not designed for use with the equipment.

Do not use a faulty or damaged power module, as this may damage the power tool.

Do not short-circuit a power module.

Do not store or transport power modules in a box or drawer where they may short-circuit each other or be short-circuited by other metal objects. This can damage the power modules and generate heat, which can cause burns.

Power modules give their best performance when they are operated at normal room temperature (20°C/68°F+/- 5°C/9°F).

Before using the power module it is important to check if it is fully charged by pressing the information button and reading the state of charge LED.

Place the power module into the charger immediately after surgery.

Only insert the power module directly before using the power tool.

Follow the information in the "Care and Maintenance" section starting on page 39 as well as the Instructions for Use of the Synthes Universal Battery Charger II (036.000.500).

---

## Precautions:

Do not

- wash
  - rinse
  - sterilize
  - drop or
  - apply force to the power module (Fig. 1). This would destroy it with possible secondary damage.
  - Only use the Synthes Universal Battery Charger II (05.001.204) to charge the power module. The use of other power sources can damage the power module.
  - Do not use faulty power modules. These should be sent to your local Synthes service center.
  - Only use the power module in the designated handpiece.
  - The power module may only be opened by the original manufacturer or an authorized Synthes office. Unauthorized opening voids the warranty.
- 



Fig. 1



### State of charge and service indicator of the power module

The power module has an information button. After briefly pressing the information button, the LED of either the state of charge or the service indicator illuminates for approximately 5 seconds.

If the service indicator or none of the LEDs illuminates, the power module needs to be sent in for repair.



#### State of charge (Fig. 1)

All four LEDs illuminate:  
The power module is fully charged.

Three or fewer LEDs illuminate:  
The power module is not fully charged. The state of charge may suffice, depending on the state of charge and the surgery. It is, however, recommended that the power module is fully charged.

Bottom LED flashes:  
The power module is fully discharged.

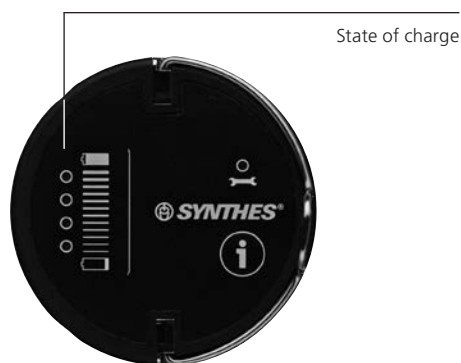

Fig. 1

#### Service indicator (Fig. 2)

The LED lights red:  
The power module is faulty. It is blocked for further use and has to be sent to be repaired.

#### Notes:

- The service indicator does not illuminate constantly. It only illuminates if the information button is pressed first and maintenance is required. The indicator lamp goes out after a few seconds to save the battery.
- If the service indicator does not illuminate this does not necessarily mean that the power module is fully functional.



Fig. 2



---

***What to do if the power module is exposed to a light mechanical shock***

1. Check the power module for signs of mechanical damage, tears, cracks, etc. Damaged power modules must not be used and have to be sent to the Synthes service center to be repaired.
2. Press the information button briefly to check the state of charge and the service indicator. If the service indicator illuminates the power module may not be used and has to be sent to be repaired.
3. Press the information button for approximately 7 seconds until the motor starts and the power module performs a self-test. If this is completed and the service indicator does not illuminate, the power module can be used. If the power module does not function properly after the self-test has been carried out, it needs to be sent in to be repaired.

*Displays when the power module is in the battery charger*

The state of charge display (or service indicator if faulty) also illuminates if the power module is in a charging bay of the switched on battery charger. In this case, the LEDs illuminate constantly.

For further information on the battery charger please consult the relevant instructions for use or your local Synthes office.

**Cleaning, care and maintenance**

The tool and all accessories should be cleaned immediately after use. Detailed cleaning instructions can be found from page 39 forward.

## Power Tool

### Handpiece (05.001.201)

- 1 Release sleeve for attachment
- 2 Trigger for speed regulation
- 3 Trigger for switching to reverse (DRILL/REAM mode) or to oscillating drilling (OSC DRILL mode); the trigger has no function in the SAW mode.
- 4 Lid
- 5 Mode switch (integrated onto lid)



Fig. 1

### Lid (05.001.231)

- 1 Mode switch
- 2 Safety button for mode switch (prevents inadvertent opening of the lid; only press to set to UNLOCK)
- 3 UNLOCK position
- 4 LOCK position
- 5 DRILL/REAM position
- 6 SAW position
- 7 OSC DRILL position

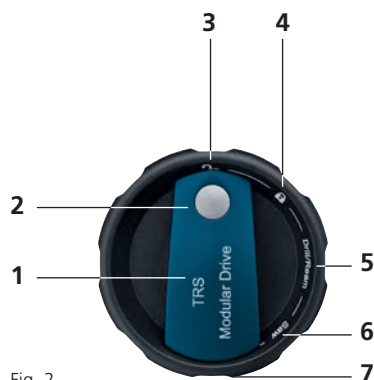

Fig. 2

---

**Power module (05.001.202)**





- 1 Information button (when pressed, the charge status display and/or service indicator illuminates for a few seconds)
- 2 Charge status display
- 3 Service indicator (when LED illuminates the power module immediately must be sent to the nearest Synthes service center)
- 4 Lever to remove the power module from the handpiece



## Functions of the Lid for TRS Battery Modular

### Mode switch

The mode switch on the lid for TRS Battery Modular (05.001.231) can be set to 5 different positions.



- 1 UNLOCK position 
- 2 LOCK position 
- 3 DRILL/REAM position 
- 4 SAW position 
- 5 OSC DRILL position 

The lid for TRS Battery Modular (05.001.231) only fits onto the TRS Battery Modular handpiece (05.001.201).



### UNLOCK position



In this position, the lid can be attached and removed. In all other positions the lid is secured so that it cannot inadvertently disengage during surgery.

To position the mode switch to UNLOCK , press the safety button on mode switch (see Fig. 2 on page 15) at the same time. This prevents inadvertent switching the mode switch to UNLOCK  and opening of the handpiece. It is not necessary to press the safety button to turn the mode switch to any other position.

### LOCK position

In this position, the tool is secured and cannot operate.

### Precautions:

- To avoid injuries, the mode switch has to be in LOCK position  when inserting/removing attachments or cutting tools and when placing the tool down.
- When preparing the tool for surgery, once the power module has been inserted the lid should be attached and tightened and then the mode switch should be set to LOCK . This prevents the handpiece being opened inadvertently.
- When the tool is not in use during the surgery, set the handpiece on its side to ensure that it does not fall over due to instability. Only place the power tool in an upright position on the sterile table to insert/remove attachments and cutting tools.
- While switching from LOCK  to one of the other positions (DRILL/REAM, SAW, OSC DRILL), a trigger delay of 1–2 seconds will occur for reasons of safety.

---

### **DRILL/REAM, SAW and OSC DRILL positions**

Before working on the patient, ensure that the correct mode has been selected, e.g. by operating the tool in the air.

#### ***DRILL/REAM mode***

This mode is suitable for all rotating attachments:

- Drill attachments (blue color marking and DRILL)
- Ream attachments (red color marking and REAM)
- Screw attachment (red color marking and SCREW)
- DHS/DCS quick coupling
- Kirschner wire attachment
- Torque limiter
- Adapter for radiolucent drive

The attachments are described in detail from page 22 forward.

The rotating attachments are most effective in the DRILL/REAM mode. They are much slower and less efficient in the SAW mode. When using rotating attachments in SAW mode, no reverse mode is available.

#### ***Working in DRILL/REAM mode***

The bottom trigger gradually controls the forward speed. If the top trigger is also pressed the tool immediately switches to reverse. When the bottom trigger is released, the tool immediately stops.

#### ***SAW mode***

This mode is designed for saw attachments and the reciprocating saw attachment.

The attachments are described in detail from page 26 forward.

#### ***Working in SAW mode***

The bottom trigger gradually controls the speed. The top trigger has no function in SAW mode, i.e. there is no effect if the top trigger is pressed. When the bottom trigger is released, the tool immediately stops.

#### ***OSC DRILL mode***

The oscillating drilling movement in oscillating mode prevents tissue and nerves from wrapping around the drill. This can considerably improve the operating results.



This mode is therefore suitable for drill attachments (05.001.205, 05.001.206, 05.001.208, 05.001.217, 05.001.219 and 05.001.221). An oscillating insertion of Kirschner wires is also possible with the Kirschner wire attachment (05.001.212).

#### ***Working in OSC DRILL mode***

Pressing the bottom trigger by itself causes the tool to rotate clockwise as usual. Simultaneously pressing the top and bottom triggers causes the tool to immediately switch to oscillating mode. The clamped cutting tool oscillates clockwise/counterclockwise. The speed can be changed by means of the bottom trigger. After the top trigger is released, the tool returns to normal clockwise rotation.

---

#### **Precautions:**

- Use all saw attachments only in SAW mode. Using the incorrect mode will effect performance and wear.
  - When using rotating attachments in SAW mode, no reverse mode is available.
  - You can only switch to reverse by turning the mode switch to “DRILL/REAM” position.
  - The maximum cutting speed of an attachment is less in OSC DRILL mode than in DRILL/REAM mode.
  - Only use oscillation mode with the above mentioned attachments.
  - While switching from LOCK  to one of the modes a trigger delay of 1–2 seconds will occur for reasons of safety.
  - To avoid injuries, the mode switch has to be in LOCK position  when inserting / removing attachments or cutting tools and when placing the tool down.
-

## Attachments for TRS Battery Modular

### Important notes

The following applies to all attachments:

#### Precautions:

- Always secure (LOCK ) the tool when connecting/ disconnecting attachments and cutting tools.
- After inserting a cutting tool, always check that it is properly seated by pulling it.
- Only use original Synthes attachments and cutting tools.
- Damage that arises from using attachments and cutting tools by other manufacturers is not covered by the warranty.
- The use of irrigation fluid is recommended in order to cool the cutting tools and prevent heat necrosis.
- Check the cutting tools for wear and/or damage after each use, and replace if necessary. Synthes recommends that cutting tools are only used once.
- Always use the attachments in the correct mode (DRILL/ REAM, SAW, OSC DRILL).
- Use all saw attachments only in SAW mode. Using the incorrect mode will affect performance and wear.
- When using rotating attachments in SAW mode, no reverse mode is available.

### Color marking on the attachments

Some rotating attachments are available in two speeds: Drilling and reaming speed. The attachments are marked accordingly (Fig. 1 and 2):

- Drill attachments (approximately 1450 rpm idle speed): blue color marking and DRILL
- Ream attachments (approximately 330 rpm idle speed): red color marking and REAM

The screw attachment is specially coded so that it can easily be recognized:

- Screw attachment (approximately 330 rpm idle speed): red color marking and SCREW.



Fig. 1: Chuck with drilling speed (text DRILL and blue color marking)



Fig. 2: Chuck with reaming speed (text REAM and red color marking)

---

### Mounting the attachments

The attachments can be connected in 8 different positions (45° increments). To mount, turn the release sleeve for the attachments clockwise (see arrow on the release sleeve) until it engages (Fig. 1), so that it jumps forwards slightly. The yellow marking on the sleeve is then visible.

Insert the attachment in the selected position into the release sleeve from the front and press it lightly against the handpiece (Fig. 2). The attachment automatically engages. If the release sleeve inadvertently automatically closes before the attachment has engaged, it is also possible to couple the attachment by pushing and turning the attachment clockwise against the sleeve (Fig. 3). Once it is connected check if the attachment is seated correctly by gently pulling on it.

Reset the mode switch to the desired mode (DRILL/REAM, SAW, OSC DRILL). The tool is ready to use. Before working on the patient again, ensure that the correct mode has been selected, e.g. by operating the device in the air.

### Changing cutting tools on attachments

See detailed explanations about each attachment from page 22 forward.

### Switching the mode

Stop the tool (release the bottom trigger) and remove it from the patient. Then turn the mode switch to the desired position. Before working on the patient again, ensure that the correct mode has been selected, e.g. by operating the device in the air.

---

### Precautions:

- Do not operate the mode switch when the device is on.
  - To avoid injuries, the locking mechanism of the tool has to be activated before every manipulation and before placing the tool back down, i.e. the mode switch has to be in the LOCK position.
  - Only use original attachments and tools from Synthes. Damage that arises from using attachments and tools made by other manufacturers is not covered by the warranty.
- 

Original attachments refer to warranty/liability.



Fig. 1



Fig. 2



Fig. 3

---

### Removing the attachments

Stop the tool (release the bottom trigger) and set the mode switch to LOCK . Place the power tool on the sterile table in an upright position for easier handling. Then hold the handpiece in one hand and with the other hand turn the release sleeve clockwise until the attachment is released (Fig. 4). Tilt the attachment slightly upwards so that it does not fall down. Place the released attachment aside.

---

**Precaution:** To avoid injuries, the mode switch has to be in LOCK position  when inserting/removing attachments or cutting tools and when placing the tool down.

---

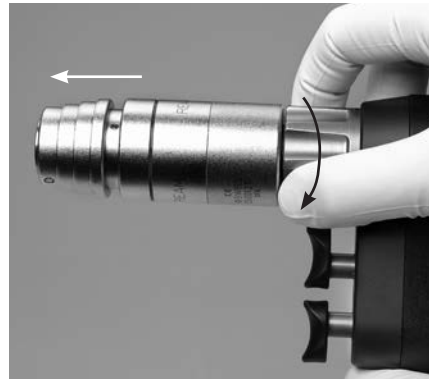

Fig. 4



---

### Rotating attachments

All Trauma Recon System Reaming Attachments provide an approximate maximal torque of 13 Nm.

#### **AO/ASIF Quick Coupling (05.001.205)**

Speed: approx. 1450 rpm  
Cannulation: 2.1 mm

##### *Inserting and removing cutting tools*

To fit the cutting tool, insert into the attachment from the front applying slight pressure and turning slightly (Fig. 1). It is not necessary to operate the coupling sleeve of the attachment.

To remove, push the coupling sleeve of the attachment back and remove the cutting tool (Fig. 2).

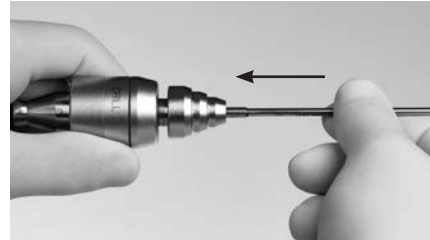

Fig. 1

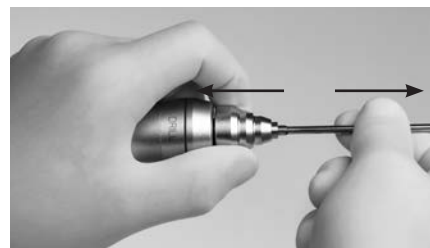

Fig. 2

---

#### **Precautions:**

- The special screw attachment (05.001.214) should be used to insert screws (see page 24).
  - After inserting a cutting tool, always check that it is properly engaged by pulling it.
  - Check the cutting tools for wear and/or damage after each use, and replace if necessary. Synthes recommends that cutting tools are only used once for patient safety.
- 

---

#### **Drill Chucks with key (05.001.206 and 05.001.207)**

Speed: approx. 1450 rpm (05.001.206)  
approx. 330 rpm (05.001.207)

Chucking range: 0.5–7.3 mm  
Cannulation: 4.1 mm

##### *Inserting and removing cutting tools*

Open the jaws of the chuck with the provided key (510.191) or by hand by turning the two moving parts clockwise against each other (Fig. 3). Insert/remove the cutting tool. Lock the chuck by turning the two moving parts counterclockwise and tighten the chuck with the key.



Fig. 3

**Drill Chuck, keyless (05.001.208)**

Speed: approx. 1450 rpm  
 Chucking range: 0.5–6.5 mm  
 Cannulation: 4.1 mm

*Inserting and removing cutting tools*

To open the chuck, pull the coupling sleeve back (marking "release" and arrow) and turn the front part of the attachment in direction to open ► (Fig. 1). Insert/remove the cutting tool. To lock, turn both parts of the attachment clockwise. When the tool is fitted, the coupling sleeve engages audibly with a click. Turn again to tighten the chuck (Fig. 2).

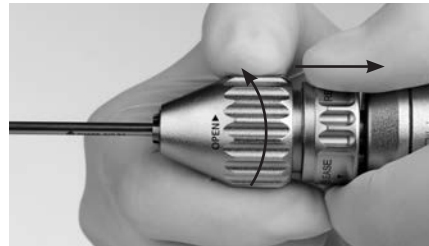

Fig. 1

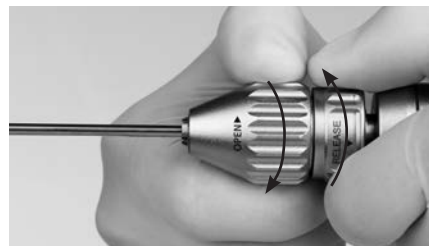

Fig. 2

**Precautions:**

- Never close the attachment by using the machine.
- After inserting a cutting tool, always check that it is properly engaged by pulling it.

**Attachment for Acetabular and Medullary Reaming (05.001.210)**

Speed: approx. 330 rpm  
 Cannulation: 4.1 mm

*Inserting and removing cutting tools*

To fit a cutting tool, insert it into the opening of the attachment and bring both parts together until they engage (Fig. 3).

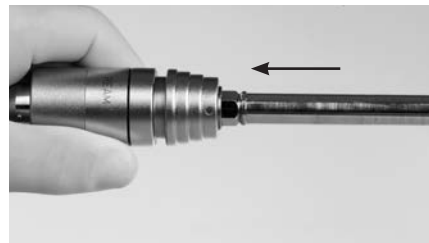

Fig. 3

To remove a tool, first pull back the movable ring on the attachment (Fig. 4) and then remove the tool.

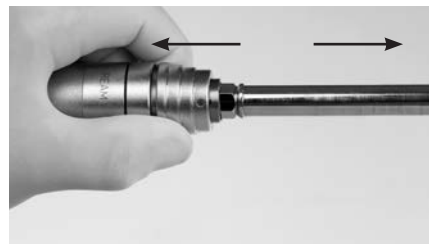

Fig. 4

**Precaution:** The attachment for acetabular and medullary reaming allows reverse mode. Only use reverse mode with tools that are approved for such use. The tool could otherwise break with consequential damage.

---

**Quick Coupling for DHS/DCS Triple Reamers  
(05.001.213)**

Speed: approx. 670 rpm  
Cannulation: 4.1 mm

**Inserting and removing cutting tools**

Pull the coupling sleeve forward and then introduce/remove the cutting tool while turning slightly (Fig. 1).

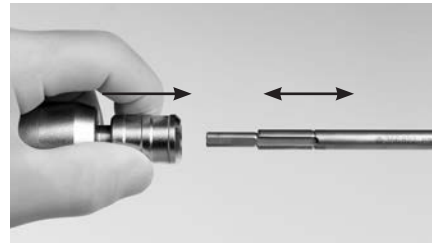

Fig. 1

---

**Screw Attachment, with AO/ASIF Quick Coupling  
(05.001.214)**

Speed: approx. 330 rpm  
Cannulation: 2.1 mm

**Inserting and removing a screwdriver shaft**

To fit the screwdriver shaft, insert into the attachment from the front applying slight pressure and turning slightly (Fig. 2). It is not necessary to operate the coupling sleeve of the attachment.

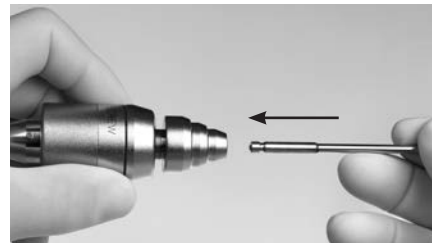

Fig. 2

To disconnect, pull the coupling sleeve of the attachment back and remove the screwdriver shaft (Fig. 3).

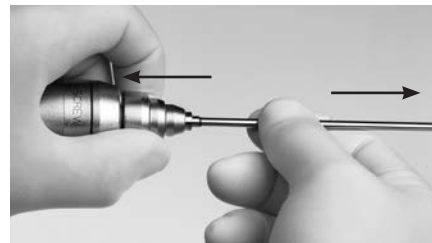

Fig. 3

---

**Precautions:**

- Care should be taken when inserting screws with the drive unit.
  - Never fully insert screws with the drive unit. The last turns or locking should always be done manually.
  - Always use an appropriate torque limiting attachment (05.001.215/05.001.216) when putting locking screws into a locking plate.
  - Theoretically, it is also possible to use the AO/ASIF Quick Coupling (05.001.205) to insert screws. The Screw Attachment (05.001.214) does, however, have a lower rpm speed and a higher torque and is therefore more suitable. Screws with a large diameter may not be able to be inserted with the AO/ASIF Quick Coupling as the torque may not suffice.
  - After inserting a cutting tool, always check that it is properly engaged by pulling it.
  - Check the cutting tools for wear and/or damage after each use, and replace if necessary. Synthes recommends that cutting tools are only used once for patient safety.
-

**Quick Couplings for cutting tools from other manufacturers**

**Hudson Quick Coupling (Drilling Speed) (05.001.217)**

Speed: approx. 1450 rpm  
 Cannulation: 4.1 mm

**Hudson Quick Coupling (Reaming Speed) (05.001.218)**

Speed: approx. 330 rpm  
 Cannulation: 4.1 mm

**Trinkle Quick Coupling (Drilling Speed) (05.001.219)**

Speed: approx. 1450 rpm  
 Cannulation: 4.1 mm

**Trinkle Quick Coupling (Reaming Speed) (05.001.220)**

Speed: approx. 330 rpm  
 Cannulation: 4.1 mm

**Trinkle Quick Coupling (Drilling Speed), modified (05.001.221)**

Speed: approx. 1450 rpm  
 Cannulation: 4.1 mm

**Trinkle Quick Coupling (Reaming Speed), modified (05.001.222)**

Speed: approx. 330 rpm  
 Cannulation: 4.1 mm

*Inserting and removing cutting tools*

Pull the coupling sleeve back and completely introduce/remove the tool while turning slightly (Fig. 1).

These instructions apply for all attachments on this page.

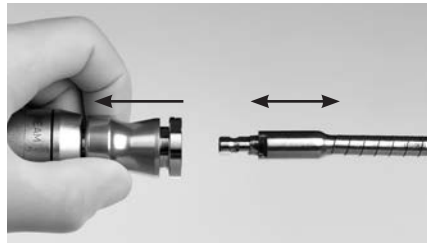

Fig. 1

---

**Precautions:** During reaming procedure, high torque values must be provided by the power tool to the reaming head to allow efficient bone removal. In cases where the reaming head is suddenly blocked, these high torque values can be transferred onto the user's hand, wrist and/or the patient's body. In order to prevent injuries it is therefore essential that:

- the power tool is held in an ergonomic position with a firm grip.
- if the reamer head blocks, the speed trigger is released immediately.
- the correct function of the speed trigger (immediate stop of the system when the trigger is released) is to be checked before the reaming process.

---

---

## Saw attachments

### ***Working with saw attachments***

Allow the unit to start up before placing it on the bone. Avoid excess pressure on the saw blade so as not to jam it. The best sawing performance is achieved by moving the tool slightly back and forth in the plane of the saw blade so that the blade can go a bit beyond the bone on both sides. Very precise cuts can be made when the saw blade is guided steadily. Imprecise cuts indicate worn saw blades, excessive pressure or jamming of the saw blade due to tilting.

### ***Instructions for handling saw blades***

For best results, Synthes recommends using a new saw blade for each operation. This ensures that the saw blade is optimally sharp and clean. The following risks are associated with used blades:

- Necrosis caused by excessive heat build-up
- Infection caused by residue
- Extended cutting time from poor sawing performance

Noise and vibration values can differ significantly when:

- working with other than typical saw blades
- sawing vertically
- working with poorly maintained tools
- working with saw blades from a different supplier
- not working in SAW mode

Saw blades must be cooled with irrigation liquid to prevent heat necrosis.

---

**Precaution:** Use all saw attachments only in SAW mode. Using the incorrect mode will effect performance and wear. Saw blades labeled "Single Use" should not be reused.

---

### **Sagittal Saw Attachment, long (05.001.224)**

For large bone heavy duty trauma applications and total joint replacement

Frequency: approx. 11,000 osc/min

Deflection: approx. 4.5° (approx. 2.25° on each side)

#### *Changing the saw blades*

Only use original Synthes saw blades. These are designed to meet the specific requirements of the tool. Generic products can considerably reduce the life time of the system.

1. Lock the machine.
2. Open the saw blade screw coupling by turning the key (05.001.229) counterclockwise.
3. Lift and remove the saw blade.
4. Insert a new saw blade and move it into the desired position. The saw blade can be locked in eight different positions.
5. Lock the saw blade coupling by turning the key clockwise and **make sure that the screw is firmly tightened.** Otherwise the screw can loosen during use causing the saw blade to vibrate.



**Precaution:** Use all saw attachments only in SAW mode. Using the incorrect mode will effect performance and wear.

### **Sagittal Saw Attachment (05.001.223)**

For large bone heavy duty trauma applications

Frequency: approx. 11,000 osc/min

Deflection: approx. 4.5° (approx. 2.25° on each side)

#### *Changing the saw blades*

Only use original Synthes saw blades. These are designed to meet the specific requirements of the tool. Generic products can considerably reduce the life time of the system.

1. Lock the machine.
2. Open the saw blade quick coupling by rotating the locking knob counter-clockwise (Fig. 1).
3. Lift and remove the saw blade (Fig. 2).
4. Insert a new saw blade and move it into the desired position. The saw blade can be locked in five different positions.
5. Lock the saw blade coupling by tightening the fixation knob clockwise. Make sure that the fixation knob is firmly tightened. Otherwise the screw can loosen during use causing the saw blade to vibrate.



Fig. 1



Fig. 2

**Precaution:** Use all saw attachments only in SAW mode. Using the incorrect mode will effect performance and wear.

---

### **Reciprocating Saw Attachment (05.001.225)**

Frequency: approx. 11,000 osc/min

Stroke: approx. 4 mm

#### *Changing the saw blades*

Only use original Synthes saw blades. These are designed to meet the specific requirements of the tool. Generic products can considerably reduce the life time of the system.

1. Lock the machine.
2. Turn the lock knob in the direction of the arrow until the saw blade jumps forward approx. 1 mm (Fig. 1).
3. Remove the saw blade (Fig. 2).
4. Insert a new saw blade until the locking knob clicks back into the locking position.
5. Check if the saw blade is seated tightly by pulling in a lengthwise direction.



Fig. 1

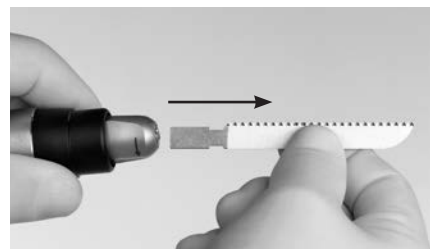

Fig. 2

---

### **Top for Sternum for Reciprocating Saw Attachment (511.904)**

#### *Mounting and removing the attachment*

Use the Top for Sternum together with the Reciprocating Saw Attachment (05.001.225). To fit, the Top for Sternum can be placed on the Reciprocating Saw Attachment and tightened with the provided Allen Key 314.140 (Fig. 3). Make sure that the Top for Sternum is seated well. To remove, release with the Allen Key and remove from the Reciprocating Saw Attachment.

#### *Changing the saw blades*

Use the same procedure as for the Reciprocating Saw Attachment (05.001.225).



Fig. 3

---

#### **Precautions:**

- Only use the Saw Blade 511.915 for the Top for Sternum Attachment. The length of this saw blade is adapted to the Top for Sternum Attachment.
  - Use all saw attachments only in SAW mode. Using the incorrect mode will affect performance and wear.
-

**Quick Coupling for Kirschner Wires (05.001.212)**

Maximum speed: approx. 1450 rpm

Cannulation: 4.0 mm (fully open)

To insert/remove Kirschner wires, 1.0–4.0 mm diameter (any length).

*Insert a Kirschner wire into the attachment*

Set the adjusting sleeve at the end of the attachment to the appropriate diameter of the Kirschner wire (Fig. 1). Insert the Kirschner wire into the front of the attachment. The Kirschner wire is lightly held in the selected position (Fig. 2).

*Insert a Kirschner wire into bone*

Grasp the Kirschner wire by pulling the lever against the handpiece (Fig. 3), and press the bottom (forward) trigger. Release the lever to reposition the attachment on the wire, if required.

*Remove a Kirschner wire from bone*

Set the appropriate diameter on the attachment adjusting sleeve. Slide the drive unit and coupling over the Kirschner wire. Grasp the wire by pulling the lever toward the handpiece and press both triggers (reverse) simultaneously to remove the wire from the bone.



Fig. 1



Fig. 2



Fig. 3



---

## Radiolucent Drive

### Adapter for Radiolucent Drive (05.001.226)

Speed: approx. 1500 rpm

#### *Coupling the Radiolucent Drive to the power tool*

Mount the adapter for Radiolucent Drive on the handpiece. Push the radiolucent drive (511.300) as far as it will go over the adapter (Fig. 1), and rotate it into the desired working position. Support the drive with your free hand (Fig. 2).

For removal, follow the same procedure in reverse.

#### *Inserting and removing drill bits*

To insert the drill bit, pull the ring on the attachment forward, and push the drill bit into the coupling as far as it can go while rotating it slightly (Fig. 3). Engage the ring on the attachment back to fix the drill bit. Check if the drill bit is seated correctly by gently pulling on it.

To remove the drill bit follow the same procedure in reverse.

---

### Precautions:

- Grip the coupled Radiolucent Drive tightly when the tool is held downwards.
- Only special 3-flute spiral drill bits can be used. Your Synthes representative will provide you with additional drill bit information.
- Handle the Radiolucent Drive with great care. Do not allow contact between the drill bit and the medullary nail.
- Depending on the setting of the image intensifier, a zone may appear in the rear of the Radiolucent Drive that is not radiolucent. However, this does not inhibit aiming and working with the device.
- To protect the gears, the Radiolucent Drive is equipped with a slip clutch that disengages in case of an overload and emits an audible rattling.
- The following may cause an overload:
  - Correction of the drilling angle when the cutting edges of the drill bit are completely in the bone.
  - Running into a nail with the drill bit.

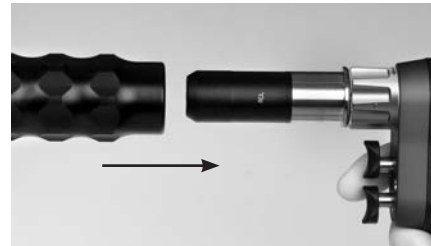

Fig. 1



Fig. 2

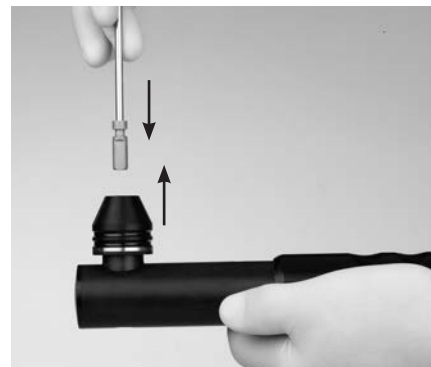

Fig. 3

- Drilling can be continued after making the following corrections:
  - Correction of the drilling angle: Remove the drill bit until the flutes are visible, and restart drilling.
  - Hitting a nail: Remove the drill bit until the flutes are visible, and re-aim the drill bit or exchange the drill bit if necessary.

---

**Using the Radiolucent Drive**

Before positioning the Radiolucent Drive, align the image intensifier until the distal locking hole of the medullary nail is round and easily visible (Fig. 1).

After the incision, position the Radiolucent Drive and center the drill bit tip over the locking hole (Fig. 2).

Swing the drive up and center it precisely so that the drill bit appears as a round point and the locking hole is visible around it (Fig. 3). The target rings also assist centring. The locking hole can now be drilled directly.

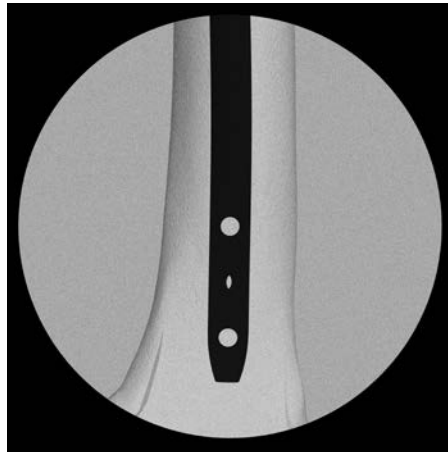

Fig. 1

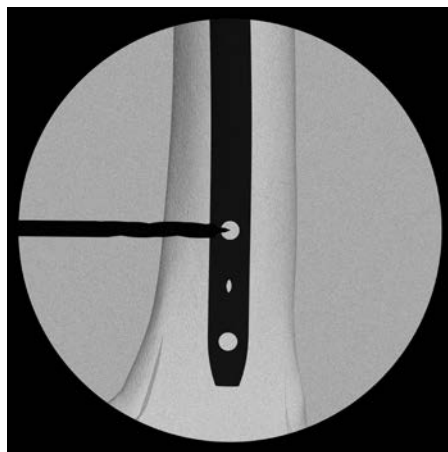

Fig. 2

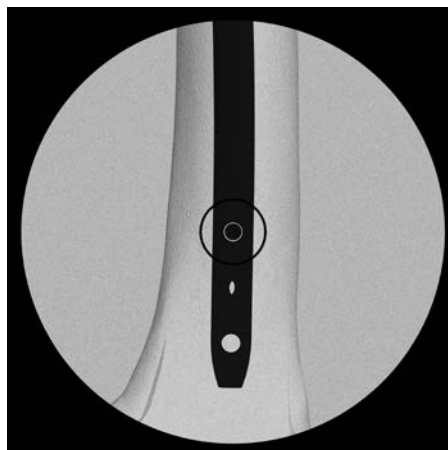

Fig. 3

---

## Torque limiters

### **Torque Limiter 1.5 Nm (05.001.215) and Torque Limiter 4.0 Nm (05.001.216)**

Speed: approx. 330 rpm

#### *Inserting and removing a screwdriver shaft*

Insert the screwdriver shaft while rotating it slightly until it locks into place (Fig. 1). To remove it, pull back the unlocking ring, and pull out the screwdriver shaft (Fig. 2).

#### *Using the Torque Limiters*

Pick up a screw from the corresponding screw/plate system with the screwdriver shaft, and insert it in the desired plate hole. To insert the screw, start the power tool slowly, increase the speed and then reduce it again before the screw is fully tightened. The torque is automatically limited to 1.5 or 4.0 Nm. When this limit is reached, you will hear a distinct clicking. Stop the tool immediately, and pull the tool away from the screw.

Follow the surgical technique of the respective screw/plate system.

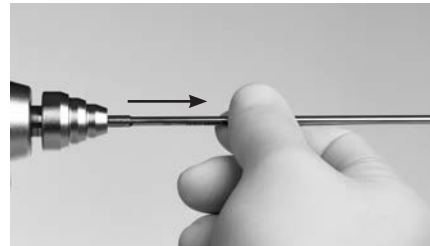

Fig. 1

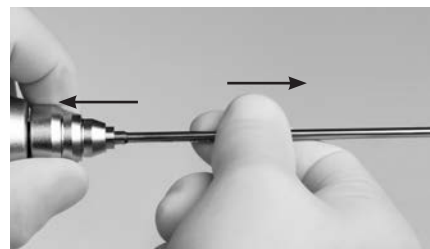

Fig. 2

---

### **Precautions:**

- Only use in connection with screw plate systems with angular stable locking.
  - Observe the recommended torque of the screw.
  - The Torque Limiters must be annually serviced and recalibrated by Synthes. Observe the information on the test certificate in the packaging. The user is responsible for following the calibration schedule.
-

# TRS Recon Sagittal Saw

## Power Tool



### Handpiece (05.001.240)

- 1 Saw blade screw coupling
- 2 Sliding sleeve for positioning saw head
- 3 Trigger for speed regulation
- 4 Lid
- 5 Mode switch (integrated onto lid)



Fig. 1

### Lid (05.001.241)

- 1 Mode switch
- 2 Safety button for mode switch (prevents inadvertent opening of the lid; only press to set to UNLOCK )
- 3 UNLOCK position 
- 4 LOCK position 
- 5 SAW position

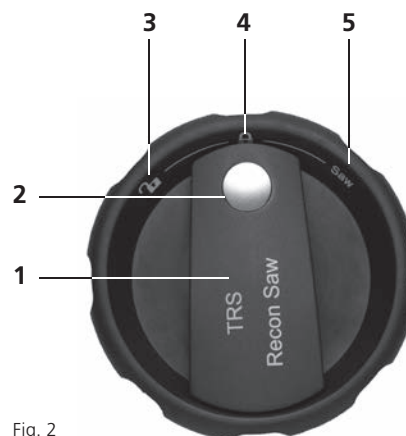

Fig. 2

---

**Power module (05.001.202)**



- 1 Information button (when pressed, the charge status display and/or service indicator illuminates for a few seconds)
- 2 Charge status display
- 3 Service indicator (when LED illuminates the power module immediately must be sent to the nearest Synthes service center)
- 4 Lever to remove the power module from the handpiece



## Functions of the Lid for TRS Recon Sagittal Saw

### Mode switch



The mode switch on the lid for TRS Recon Sagittal Saw (05.001.241) can be set to 3 different positions.

- 1 UNLOCK position 
- 2 LOCK position 
- 3 SAW position

The lid for TRS Recon Sagittal Saw (05.001.241) only fits onto the TRS Recon Sagittal Saw handpiece (05.001.240).

### UNLOCK position

In this position, the lid can be attached and removed. In all other positions the lid is secured so that it cannot inadvertently disengage during surgery.

To position the mode switch to UNLOCK , press the safety button for mode switch (see Fig. 2 on page 34) at the same time. This prevents inadvertent switching of the mode switch to UNLOCK  and opening of the handpiece. It is not necessary to press the safety button to turn the mode switch to any other position.

### LOCK position

In this position, the tool is secured and cannot operate.

### SAW mode



This mode is designed for working with the TRS Recon Sagittal Saw.

#### Working in the SAW mode

The trigger gradually controls the speed. When the trigger is released, the tool immediately stops.



### Precautions:

- When the tool is not in use during the surgery, set the handpiece on its side to ensure that it does not fall over due to instability. Only place the power tool in an upright position on the sterile table to insert/remove attachments and cutting tools.
- While switching from LOCK  to SAW, a trigger delay of 1–2 seconds will occur for reasons of safety.
- To avoid injuries, the mode switch has to be in LOCK position  when inserting/removing cutting tools and when placing the tool down.

## Working with the TRS Recon Sagittal Saw

---

### Operating the TRS Recon Sagittal Saw

Turn the mode switch to the SAW position. The single variable-speed trigger allows control of the oscillating frequency. When the trigger is released, the tool immediately stops. (Control elements see page 34).

### Positioning the saw head

The saw head can be locked into 8 different positions in 45° increments.

To set the desired position, pull the sliding sleeve back for positioning the saw head and turn the saw head to the selected position. Release the sliding sleeve. Turn the saw head slightly to the left or to the right. It automatically locks into place once the exact position is found.

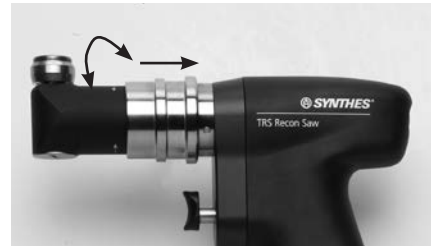



Fig. 1

---

### Precautions:

- To position the saw head, turn the mode switch on the lid to LOCK .
  - Always position the saw head with the fitted saw blade away from the body in order to avoid injury (Fig. 1).
-

---

### Changing the saw blades

Only use original Synthes saw blades. These are designed to meet the specific requirements of the tool. Generic products can considerably reduce the life time of the system.

1. LOCK the machine.
2. Open the saw blade screw coupling by turning the key (05.001.229) counterclockwise.
3. Lift and remove the saw blade.
4. Insert a new saw blade and move it into the desired position. The saw blade can be locked in eight different positions.
5. Lock the saw blade coupling by turning the key clockwise and **make sure that the screw is firmly tightened.** Otherwise the screw can loosen during use causing the saw blade to vibrate.

### Working with the TRS Recon Sagittal Saw

Allow the unit to start up before placing it on the bone. Avoid excess pressure on the saw blade so as not to jam it. The best sawing performance is achieved by moving the tool slightly back and forth in the plane of the saw blade so that the blade can go a bit beyond the bone on both sides. Very precise cuts can be made when the saw blade is guided steadily. Imprecise cuts indicate worn saw blades, excessive pressure or jamming of the saw blade due to tilting.

### Instructions for handling saw blades

For best results, Synthes recommends using a new saw blade for each operation. This ensures that the saw blade is optimally sharp and clean. The following risks are associated with used blades:

- Necrosis caused by excessive heat build-up
- Infection caused by residue
- Extended cutting time from poor sawing performance

Noise and vibration values can differ significantly when:

- working with other than typical saw blades
- sawing vertically
- working with poorly maintained tools
- working with saw blades from a different supplier
- not working in SAW mode

Saw blades must be cooled with irrigation liquid to prevent heat necrosis.



## General Information

Power tools and attachments are frequently exposed to high mechanical loads and shocks during use and should not be expected to last indefinitely. Proper handling and maintenance help extend the useful life of surgical instruments.

Frequent reprocessing does not have a great effect on the life of the unit and attachments. Gentle care and maintenance with proper lubrication can substantially increase the reliability and life of the system components.

Synthes power tools must be serviced and inspected annually by the original manufacturer or an authorized site. Yearly maintenance will ensure that the equipment maintains the highest standard of performance and will prolong the life of the system. The manufacturer assumes no warranty for damages arising from improper use, neglected or unauthorized servicing of the tool.

For more information about Care and Maintenance, please refer to the TRS Care and Maintenance Poster (038.000.010).

### Precautions:

- Reprocessing must be performed immediately after each use.
  - Cannulations, unlocking sleeves and other narrow sites require special attention during cleaning.
  - Cleaners with a pH 7–9.5 are recommended. The use of cleaners with higher pH-values can – depending on the cleaner – cause a dissolution of the surface of aluminum and its alloys, plastics or compound materials, they should only be used considering the data regarding material compatibility according to its data sheet. At pH values higher than 11 also the surfaces of stainless steel can be affected. For detailed information about material compatibility, see “Material Compatibility of Synthes Instruments in Clinical Processing” at <http://emea.depuysynthes.com/hcp/reprocessing-care-maintenance>
- Follow the enzymatic cleaner or detergent manufacturer’s instructions for use for correct dilution concentration, temperature, exposure time and water quality. If temperature and time are not provided, follow Synthes recommendations. Devices should be cleaned in a fresh, newly-made solution.
- Detergents used on the products will contact the following materials: stainless steel, aluminum, plastic, and rubber seals.

- Synthes recommends using new sterile cutting tools for each operation. Refer to “Clinical Processing of Cutting Tools” for detailed clinical processing instructions.
- Do not immerse the handpiece, power module, lid or attachments in aqueous solutions or in an ultrasonic bath. Do not use pressurized water as this will cause damage to the system.
- Synthes recommends using new sterile cutting tools for each operation. Refer to “Clinical Processing of Cutting Tools” (036.000.499) for detailed clinical processing instructions.

### Unusual Transmissible Pathogens

Surgical patients identified as at-risk for Creutzfeldt-Jakob disease (CJD) and related infections should be treated with single-use instruments. Dispose of instruments used or suspected of use on a patient with CJD after surgery and/or follow current national recommendations.

### Note

The clinical processing instructions provided have been validated by Synthes for preparing a non-sterile Synthes medical device; this instruction is provided in accordance with ISO 17664:2004 and ANSI/AAMI ST81:2004.

Consult national regulations and guidelines for additional information. Compliance is additionally required with internal hospital policies and procedures and recommendations of manufacturers of detergents, disinfectants, and any clinical processing equipment.

Cleaning Agent Information: Synthes used the following cleaning agents during validation of these reprocessing recommendations. These cleaning agents are not listed in preference to other available cleaning agents which may perform satisfactorily – neutral pH enzymatic detergents (e. g. Prolystica 2X Concentrate Enzymatic Cleaner).

It remains the responsibility of the processor to ensure that the processing performed achieves the desired result using the appropriate properly installed, maintained and validated equipment, materials and personnel in the processing unit. Any deviation by the processor from the instructions provided should be properly evaluated for effectiveness and potential adverse consequences.

## Preparation prior to Cleaning

### Disassembly

Before cleaning, remove all instruments and attachments from the power tool. Make sure that all movable parts are open and remove the power module from the handpiece.

### Power Modules and Charger

Power modules and charger may be wiped with a cloth (Figs 1 and 2).

Return power modules to Universal Battery Charger II (05.001.204) after each use (Fig. 3).

### Precautions:

- The power module must not be washed, rinsed, disinfected or sterilized.
- Do not immerse the handpiece, lid or attachments in aqueous solutions or in an ultrasonic bath as this could decrease the service life of the system.

### Notes:

- Inspect power module for cracks and damage.

The screw coupling (Fig. 6) of TRS Recon Sagittal Saw (Fig. 4) and Sagittal Saw Attachment long for TRS Battery Modular (Fig. 5) need to be removed for separate cleaning.

Handpieces and attachments may be processed using  
a) manual cleaning, or  
b) automated cleaning with manual pre-cleaning.

**Note:** Clean all movable parts in opened position.



Figure 1



Figure 2



Figure 3

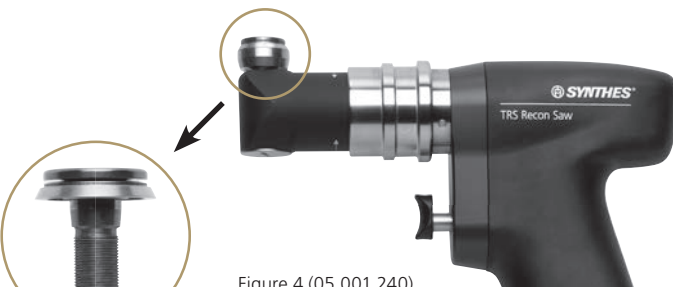

Figure 4 (05.001.240)

Figure 6 (Screw)



Figure 5 (05.001.224)

## a) Manual Cleaning Instruction

### 1

#### Remove debris

Rinse device under running cold tap water for a minimum of 2 minutes. Use a sponge, soft lint-free cloth and/or soft-bristled brush to assist in the removal of gross soil and debris. Clean all cannulations (handpieces and attachments) with the cleaning brush (516.101).



### 2

#### Manipulate moving parts

Manipulate all moving parts such as the triggers, release sleeves for attachments, mode switch, etc. under running cold tap water to loosen and remove gross debris.

#### Notes:

- Do not use pointed objects for cleaning.
- Brushes and other cleaning tools shall be either single use items or, if reusable, be decontaminated at least daily using a solution as detailed in section “3. Spray and wipe”.
- Brushes shall be inspected before daily use and discarded if they have degraded to the point where they may scratch instrument surfaces or be ineffective due to worn or missing bristles.

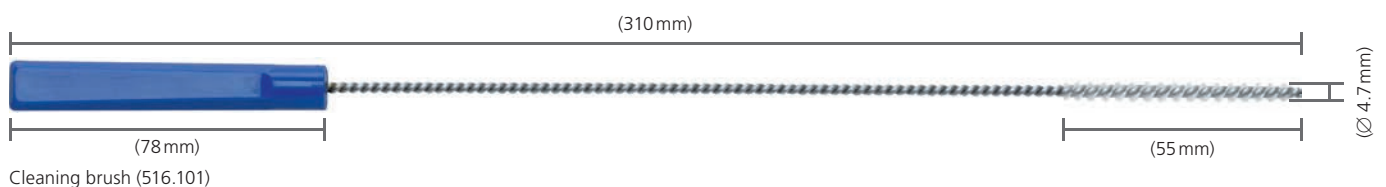

---

### 3

#### **Spray with solution**

Spray and wipe device using an enzymatic cleaner or detergent solution or foam spray for a minimum of 2 minutes.

Follow the enzymatic cleaner or detergent manufacturer's instructions for use for correct temperature, water quality and concentrations/dilution.



---

### 4

#### **Rinse with tap water**

Rinse device with cold tap water for a minimum of 2 minutes. Use a syringe or pipette to flush lumens and channels.



---

## 5

### Clean with detergent

Clean device manually under running water using an enzymatic cleaner or detergent for a minimum of 5 minutes. Manipulate all moving parts under running water. Use a soft-bristled brush and/or soft lint-free cloth to remove all visible soil and debris.

Follow the enzymatic cleaner or detergent manufacturer's instructions for use for correct temperature, water quality and concentrations/dilution.



---

## 6

### Rinse with tap water

Rinse device thoroughly using running cool to lukewarm water for a minimum of 2 minutes. Use a syringe or pipette to flush lumens and channels. Actuate joints, handles and other movable device feature in order to rinse thoroughly under running water.



---

## 7.

### Wipe / Spray disinfection

Wipe off or spray the surfaces of the devices with a minimum 70% alcohol based disinfectant.

---

## 8

### Visually inspect device

Inspect the cannulations, coupling sleeves, etc for visible soil. Repeat Steps 1–8 until no visible soil remains.

---

## 9

### Finale rinse with de-ionized/purified water

Finale rinse with de-ionized or purified water for a minimum of 2 minutes.



---

## 10

### Dry

Dry device using a soft lint-free cloth or medical grade compressed air.



## b) Mechanical /Automated Cleaning Instruction with Manual Pre-cleaning

### Important

- Manual pre-cleaning prior to mechanical/automated cleaning/disinfection is important to ensure cannulations and other difficult to access areas are clean.
- Alternative cleaning/disinfection procedures other than in the procedure described below (including manual pre-cleaning) have not been validated by Synthes.

### 1

#### Remove debris

Rinse device under running cold tap water for a minimum of 2 minutes. Use a sponge, soft lint-free cloth and/or soft-bristled brush to assist in the removal of gross soil and debris. Clean all cannulations (handpieces and attachments) with the cleaning brush (516.101).



### 2

#### Manipulate moving parts

Manipulate all moving parts such as the triggers, release sleeves for attachments, mode switch, etc. under running cold tap water to loosen and remove gross debris.

#### Notes:

- Do not use pointed objects for cleaning.
- Brushes and other cleaning tools shall be either single use items or, if reusable, be decontaminated at least daily using a solution as detailed in section "3. Spray and wipe".
- Brushes shall be inspected before daily use and discarded if they have degraded to the point where they may scratch instrument surfaces or be ineffective due to worn or missing bristles.

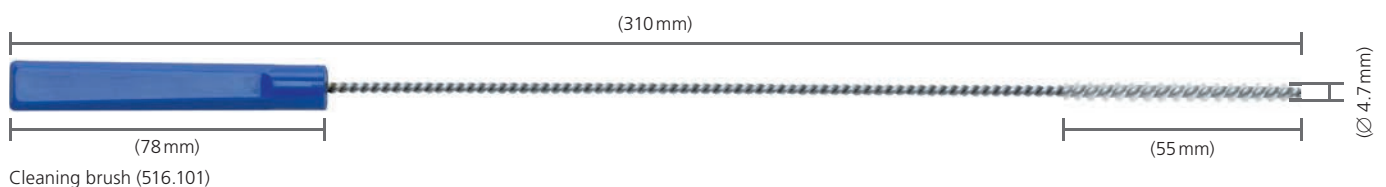



---

### 3

#### **Spray with solution**

Spray and wipe device using an enzymatic cleaner or detergent solution or foam spray for a minimum of 2 minutes.

Follow the enzymatic cleaner or detergent manufacturer's instructions for use for correct temperature, water quality and concentrations/dilution.



---

### 4

#### **Rinse with tap water**

Rinse device with cold tap water for a minimum of 2 minutes. Use a syringe or pipette to flush lumens and channels.

---

### 5

#### **Clean with detergent**

Clean device manually under running water using an enzymatic cleaner or detergent for a minimum of 5 minutes. Manipulate all moving parts under running water. Use a soft-bristled brush and/or soft lint-free cloth to remove all visible soil and debris.

Follow the enzymatic cleaner or detergent manufacturer's instructions for use for correct temperature, water quality and concentrations/dilution.





---

## 6

### Rinse with tap water

Rinse device thoroughly using running cool to lukewarm water for a minimum of 2 minutes. Use a syringe or pipette to flush lumens and channels. Actuate joints, handles and other movable device feature in order to rinse thoroughly under running water.



---

## 7

### Visually inspect device

Repeat Steps 1–7 until no visible soil remains.

Manual pre-cleaning as described above must be followed by the mechanical/automated cleaning procedure.

## 8

### Load washing basket

Place devices in the specially designed tray for machine washing supplied by Synthes (68.001.606). Ensure that all cannulations (handpiece and attachments), if applicable, are positioned vertically, i.e., in an upright position as shown.

This will ensure that the water can flow off any surfaces. Damage due to improper reprocessing is not covered by the warranty.

A loading plan for the TRS Washing Basket Full size 1/1 is available as a single document (DSEM/PWT/1116/0123).

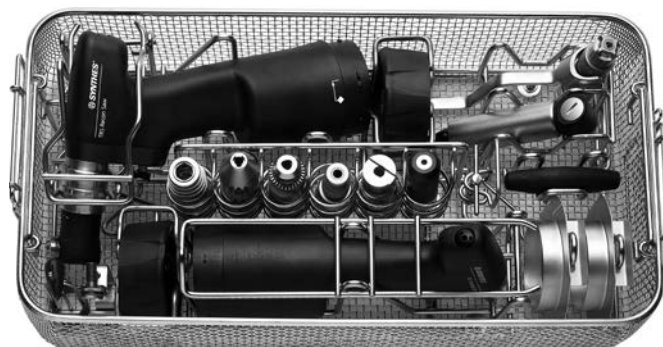

#### Notes:

- A lid (68.001.602) is available for the washing basket. This can be used for sterilization, but is not required for machine washing.
- Do not wash the system in the Synthes Vario Cases (68.001595, 68.001.592).

### Dimensions of the Washing Basket

(Length × Width × Height):

Washing Basket without Lid: 500 × 250 × 127 mm

Washing Basket with Lid: 504 × 250 × 150 mm

## 9

### Automated cleaning cycle parameters

**Note:** The washer/disinfector should fulfill requirements specified in ISO 15883.

| Step                 | Duration (minimum) | Cleaning Instructions                               |
|----------------------|--------------------|-----------------------------------------------------|
| Rinse                | 2 minutes          | Cold tap water                                      |
| Pre-wash             | 1 minutes          | Warm water ( $\geq 40$ °C); use detergent           |
| Cleaning             | 2 minutes          | Warm water ( $\geq 45$ °C); use detergent           |
| Rinse                | 5 minutes          | Rinse with de-ionized (DI) or purified water (PURW) |
| Thermal disinfection | 5 minutes          | Hot DI water, $\geq 93$ °C                          |
| Dry                  | 40 minutes         | $\geq 90$ °C                                        |

---

## 10

### Inspect device

Remove all devices from washing basket. Inspect the cannulations, coupling sleeves, etc. for visible soil. If necessary, repeat the manual pre-clean/automated cleaning cycle.

Especially check sealings in the TRS lids 05.001.231 and 05.001.241 for damage after cleaning. Devices must be properly lubricated and regularly send to be serviced (at least once per year). Confirm that all parts are completely dry.

---

**Precaution:** Mechanical cleaning is an additional stress for power equipment, especially for seals and bearings. Therefore, devices must be properly lubricated after automated cleaning. Furthermore, the device must be serviced at least once per year as specified under the section "Repair and Technical Services" on page 52.

---

## Maintenance and Lubrication

The power tools and attachments should be regularly lubricated to ensure a long service life and smooth operation. It is recommended that the accessible moving parts of the handpieces, the lids and attachments are lubricated with 1–2 drops of Synthes special oil (519.970) and distribute the oil by moving the components. Wipe off excess oil with a cloth.

### The following individual parts must be lubricated:

For detailed information please refer to the TRS Care and Maintenance Poster (038.000.010)

#### Handpieces and lids

- Trigger shafts
- Release sleeve for attachments/attachment coupling
- Sliding sleeve for positioning saw head
- Safety button for mode switch

The connection of the power module in the inside of the handpiece does not have to be lubricated. Also the inner side of the lid does not have to be lubricated.

#### Attachments

All moving parts of all attachments. Exception: the Radio-lucent Drive (511.300) does not have to be lubricated.



---

**Precautions:**

- The power module does not have to be lubricated.
  - To ensure a long service life and reduce repairs, the handpiece, lid and attachments must be lubricated after each use.
  - Attachments and accessories may only be lubricated with Synthes Special Oil (519.970). The composition of the vapor-permeable oil is optimized for the specific requirements of the power tool. Lubricants with other compositions can cause jamming and have a toxic effect or can have a negative impact on the sterilization results.
  - Only lubricate the power tool and the attachments when clean.
-

## Inspection and Function Test

---

### **Instructions**

Visually inspect for damage and wear (e.g. unrecognizable markings, missing or removed part numbers, corrosion, etc.).

Check the handpiece controls for smooth operation and function.

All movable parts should be moving smoothly. Check that the triggers do not remain blocked in the handpiece when pressing on them. Check that no residuals prevent the movable parts from moving smoothly.

Check the release ring of the handpiece and attachments for smooth operation, and check for function together with cutting tools.

Check instruments and cuttings tools for correct adjustment and functioning prior to every use.

Do not use damaged, worn or corroded components but send them instead to the Synthes Service Center.

Failing to follow these instructions will lead to damage and malfunction, increasing the risk of harm to the user and patient.

For further information on inspection and function test, please refer to the TRS Care and Maintenance Poster (038.000.010).

## Packaging, Sterilization and Storage

### Packaging

Put cleaned, dry products into their respective places in the Synthes case or washing basket. Additionally, use an appropriate sterilization wrap or re-usable rigid container system for sterilization, such as a Sterile Barrier System according to ISO 11607. Care should be taken to protect implants, and pointed and sharp instruments from contact with other objects that may damage the surface or the Sterile Barrier System.

### Sterilization

**Warning:** For the sterilization of the TRS system, Synthes recommends the use of the specifically designed Synthes Vario Case (68.001.595) or of the specifically designed Washing Basket (68.001.606).

Synthes Trauma Recon System may be re-sterilized using validated steam sterilization methods (ISO 17665 or national standards). Synthes recommendations for packed devices and cases are as follows.

| Cycle type                                                         | Sterilization exposure time | Sterilization exposure temperature | Dry time      |
|--------------------------------------------------------------------|-----------------------------|------------------------------------|---------------|
| Saturated steam-forced air removal (pre-vacuum) (minimum 3 pulses) | Minimum 4 minutes           | Minimum 132 °C<br>Maximum 138 °C   | 20–60 minutes |
|                                                                    | Minimum 3 minutes           | Minimum 134 °C<br>Maximum 138 °C   | 20–60 minutes |

Dry times generally range from 20 to 60 minutes due to differences in packaging materials (Sterile Barrier System, e.g., wraps or re-usable rigid container systems), steam quality, device materials, total mass, sterilizer performance and varying cool-down time.

### Precautions:

- The following maximum values may not be exceeded: 143 °C over a maximum of 22 minutes. Higher values can damage the sterilized products.
- Do not accelerate the cooling process.
- Hot air, ethylene oxide, plasma and formaldehyde sterilization are not recommended.
- The power module must not be sterilized. This would destroy the power module with possible secondary damage.

### Storage

Storage conditions for products labeled “STERILE” are printed on the packaging label.

Packaged and sterilized products should be stored in a dry, clean environment, protected from direct sunlight, pests, and extremes of temperature and humidity. Use products in the order in which they are received (“first-in, first-out principle”), taking note of any expiration date on the label.

## Repairs and Technical Service

---

The power tool should be sent to the Synthes office for repair if it is faulty or malfunctions.

Contaminated products have to run through the complete reprocessing procedure before being sent to the Synthes office for repair or technical service.

To prevent damage during shipping use the original packaging to return devices back to Synthes. If the packing material is no longer available, please contact the Synthes affiliate.

This system requires regular maintenance service, at least once a year, in order to maintain its functionality. This service has to be performed by the original manufacturer or an authorized site.

Faulty devices may not be used. If it is no longer possible or feasible to repair the power tool it should be disposed of, cf. the following section "Disposal of Waste".

Other than the above-mentioned care and maintenance, no further maintenance work may be carried out independently or by third parties.

Please refer to the regulations for transporting Li-Ion batteries when returning them to the Synthes Service Center.

The manufacturer excludes liability for damage resulting from improper use, neglected or unauthorized servicing of the tool.



## Disposal

---

In most cases, faulty power tools can be repaired (refer to the previous section "Repairs and Technical Service").

Please send devices that are no longer used to your local Synthes representative. This ensures that they are disposed of in accordance with the national application of the respective directive. The device may not be disposed of with household waste.

To prevent damage during shipping, use the original packaging to return devices back to Synthes. If this is not possible, please contact the Synthes affiliate.

Faulty power modules may not be reused and should be disposed of in an environmentally friendly manner and in accordance with national regulations.



The European Battery Directive 2006/66/EC applies to this device. This device contains Lithium-Ion batteries that should be disposed of in accordance with environment protection requirements.

---



**Precaution:** Contaminated products have to run through the complete reprocessing procedure, so that there is no danger of infection in case of disposal.

---

### Warnings:

- Risk of fire, explosion and burns. Do not disassemble, crush, heat above 60°C/140°F or incinerate the power module and battery cells.
  - Never expose the power module to temperatures over 60°C/140°F. The maximum exposure time at 60°C/140°F is 72 hours.
  - Do not dismantle, open or shred the power module.
-

## Handpiece and Lid

| Problem                                                      | Possible causes                                                                                                                         | Solution                                                                                                                                                  |
|--------------------------------------------------------------|-----------------------------------------------------------------------------------------------------------------------------------------|-----------------------------------------------------------------------------------------------------------------------------------------------------------|
| Tool does not start.                                         | No power module in handpiece.                                                                                                           | Insert charged power module.                                                                                                                              |
|                                                              | The power module is flat.                                                                                                               | Charge power module.                                                                                                                                      |
|                                                              | Pulling the trigger immediately after turning the mode switch does not start the motor (Power module performs a check).                 | After turning the mode switch, do not pull the triggers and wait for 2–3 seconds.                                                                         |
|                                                              | Safety system is activated (mode switch set to LOCK  . | Set mode switch to DRILL/REAM, SAW or OSC DRILL.                                                                                                          |
|                                                              | The machine has automatically switched off because it was not used for a long time (energy saving feature).                             | Set mode switch to LOCK  and then back to the applicable operating mode. |
|                                                              | The power module is faulty (service indicator illuminates when the information button is pressed).                                      | Send power module to Synthes service center.                                                                                                              |
|                                                              | Overheat protection active.                                                                                                             | Allow machine to cool.                                                                                                                                    |
| Tool does not have enough power.                             | The power module is flat.                                                                                                               | Charge power module.                                                                                                                                      |
|                                                              | The wrong attachment is used (e.g. an attachment with drilling speed instead of reaming speed).                                         | Change attachment.                                                                                                                                        |
|                                                              | Machine and/or attachments have not been properly serviced.                                                                             | Send machine and attachments to Synthes service center.                                                                                                   |
| The machine stops suddenly.                                  | The power module is flat.                                                                                                               | Charge power module.                                                                                                                                      |
|                                                              | The tool is overheated (overload protection is activated).                                                                              | Allow machine to cool.                                                                                                                                    |
|                                                              | Machine is faulty.                                                                                                                      | Send machine to your Synthes service office.                                                                                                              |
| Power tool continues to operate after releasing the trigger. | The trigger is blocked by deposits of blood, etc.                                                                                       | Press trigger several times; clean and oil according to instructions. Use only Synthes Special Oil (519.970).                                             |
|                                                              | The power module is defective.                                                                                                          | Send power module to Synthes service center.                                                                                                              |
| Machine noticeably heats up.                                 | Machine is under great strain.                                                                                                          | Allow machine to cool.                                                                                                                                    |

| <b>Problem</b>                                                   | <b>Possible causes</b>                                                                                                                                                   | <b>Solution</b>                                                                                                                                                        |
|------------------------------------------------------------------|--------------------------------------------------------------------------------------------------------------------------------------------------------------------------|------------------------------------------------------------------------------------------------------------------------------------------------------------------------|
| TRS Battery Modular runs too slowly.                             | Wrong mode set (SAW instead of DRILL/REAM).                                                                                                                              | Set correct mode (DRILL/REAM) for drilling and reaming attachments.                                                                                                    |
|                                                                  | The wrong attachment is used (e.g. an attachment with reaming speed instead of drilling speed).                                                                          | Change attachment.                                                                                                                                                     |
| TRS Battery Modular saws too fast/ too aggressively.             | Wrong mode set (DRILL/REAM instead of SAW).                                                                                                                              | Set correct mode (SAW) for saw attachments.                                                                                                                            |
| Attachments cannot be coupled to the TRS Battery Modular.        | The attachment coupling is plugged from deposits.                                                                                                                        | Remove particles, for example with blunt tweezers.                                                                                                                     |
| Attachments cannot be disconnected from the TRS Battery Modular. | Release sleeve for attachments is blocked/plugged with deposits.                                                                                                         | Check release sleeve, clean and lubricate if necessary (Synthes Special Oil 519.970). Send machine to your Synthes service center if necessary.                        |
| Lid cannot be fitted onto the handpiece.                         | Lid was not properly aligned.                                                                                                                                            | Check markings on lid and handpiece and align lid properly.                                                                                                            |
|                                                                  | Mode switch is not in UNLOCK position  .                                              | Set mode switch to UNLOCK position  .                                             |
|                                                                  | Wrong lid has been attached.                                                                                                                                             | Check if the right lid has been used (Lid 05.001.231 for TRS Battery Modular handpiece 05.001.201 and Lid 05.001.241 for TRS Recon Sagittal Saw handpiece 05.001.240). |
| Lid cannot be removed from handpiece.                            | Mode switch is not in UNLOCK position  .                                              | Set mode switch to UNLOCK position  .                                             |
| Mode selector switch cannot be switched.                         | Mode switch is blocked/plugged with deposits.                                                                                                                            | Check mode switch, clean and lubricate if necessary. Send machine to your Synthes service center if necessary.                                                         |
|                                                                  | The safety button was not pressed to switch the mode switch to the UNLOCK position  . | Press safety button and simultaneously turn mode switch to UNLOCK  .              |

| <b>Problem</b>                                     | <b>Possible causes</b>                        | <b>Solution</b>                                                                                   |
|----------------------------------------------------|-----------------------------------------------|---------------------------------------------------------------------------------------------------|
| The triggers are difficult to move.                | Trigger shafts are plugged with deposits.     | Clean and lubricate trigger. Only use Synthes Special Oil (519.970).                              |
|                                                    | The trigger shafts need to be lubricated.     | Lubricate trigger shafts. Only use Synthes Special Oil (519.970).                                 |
| Power module cannot be inserted into handpiece.    | Power module was inserted in wrong direction. | Turn power module by 180° and insert again. Check the form of the power module and the handpiece. |
| Power module cannot be removed from the handpiece. | Power module is jammed in the handpiece.      | Send machine to your Synthes service center.                                                      |

## Power Module

| Problem                                                                            | Possible causes                                                                                                                           | Solution                                                                                                                                     |
|------------------------------------------------------------------------------------|-------------------------------------------------------------------------------------------------------------------------------------------|----------------------------------------------------------------------------------------------------------------------------------------------|
| Power module cannot be inserted into handpiece.                                    | Power module was inserted in wrong direction.                                                                                             | Turn power module by 180° and insert again. Pay attention to the form of the power module and the handpiece.                                 |
| Power module cannot be removed from the handpiece.                                 | Power module is jammed in the handpiece.                                                                                                  | Send machine to your Synthes service center.                                                                                                 |
| Fully charged power module does not work.                                          | The machine has automatically switched off because it was not used for a long time (energy saving feature).                               | Set mode switch to LOCK  and then back to the desired mode. |
|                                                                                    | Pulling the trigger immediately after turning the mode switch does not start the motor (power module performs a check).                   | After turning the mode switch, do not pull the triggers and wait for 2–3 seconds.                                                            |
|                                                                                    | Safety system is activated (mode switch set to LOCK  . | Set mode switch to DRILL/REAM, SAW or OSC DRILL.                                                                                             |
|                                                                                    | The power module is faulty because it was, for instance, dropped after being removed from the battery charger or contacted with liquids.  | Send power module to Synthes service center.                                                                                                 |
| Charge status display does not illuminate despite pressing the information button. | The power module is faulty.                                                                                                               | Send power module to Synthes service center.                                                                                                 |
| Service indicator lamp is on constantly.                                           | The power module is faulty.                                                                                                               | Send power module to Synthes service center.                                                                                                 |
| State of charge LED illuminate constantly.                                         | The power module is in the battery charger.                                                                                               | No fault. In the switched on battery charger, the state of charge LED or the service indicator illuminate constantly.                        |
|                                                                                    | The power module is faulty.                                                                                                               | Send power module to Synthes service center.                                                                                                 |
| Power module was sterilized or washed by accident and is now faulty.               | Staff negligence.                                                                                                                         | Send power module to Synthes service center.                                                                                                 |
| Power module casing is visibly faulty.                                             | The power module was exposed to excessively high temperatures.                                                                            | Send power module to Synthes service center.                                                                                                 |
|                                                                                    | The power module was dropped.                                                                                                             | Send power module to Synthes service center.                                                                                                 |

## Attachments and Cutting Tools

| <b>Problem</b>                                                             | <b>Possible causes</b>                                                                          | <b>Solution</b>                                                                                                                                    |
|----------------------------------------------------------------------------|-------------------------------------------------------------------------------------------------|----------------------------------------------------------------------------------------------------------------------------------------------------|
| Attachments cannot be coupled to the TRS Battery Modular.                  | The attachment coupling is plugged from deposits.                                               | Remove particles, for example with blunt tweezers.                                                                                                 |
| Attachments cannot be disconnected from the TRS Battery Modular.           | Release sleeve for attachments is jammed/blocked by deposits.                                   | Check release sleeve and clean and lubricate if necessary (Synthes Special Oil 519.970). Send machine to your Synthes service center if necessary. |
| Cutting tool is difficult to couple or cannot be coupled to an attachment. | The attachment or cutting tool is deformed from wear.                                           | Replace the attachment or cutting tool, or send it to a Synthes service center.                                                                    |
| Attachment noticeably heats up.                                            | Attachment was under great strain.                                                              | Allow attachment to cool.                                                                                                                          |
| Rotating attachment turns too slowly.                                      | Wrong mode set (SAW instead of DRILL/REAM).                                                     | Set correct mode (DRILL/REAM) for drilling and reaming attachments.                                                                                |
|                                                                            | The wrong attachment is used (e.g. an attachment with reaming speed instead of drilling speed). | Change attachment.                                                                                                                                 |
| Kirschner wire cannot be inserted into the Kirschner wire attachment.      | Kirschner wire attachment is not opened.                                                        | Fully open the adjustment sleeve at the end of the attachment, insert the Kirschner wire and close the adjustment sleeve.                          |
| Kirschner wire cannot be secured despite pulling the tension lever.        | Kirschner wire attachment is opened too far.                                                    | Close the adjustment sleeve at the end of the attachment until the wire is tensioned. Then release by one or two clicks.                           |
| Kirschner wire is jammed in the attachment and cannot be moved.            | Kirschner wire was inserted at an angle and is jammed in the attachment.                        | Send Kirschner wire attachment to Synthes service center.                                                                                          |

| <b>Problem</b>                                                       | <b>Possible causes</b>                                    | <b>Solution</b>                                                                                                                              |
|----------------------------------------------------------------------|-----------------------------------------------------------|----------------------------------------------------------------------------------------------------------------------------------------------|
| Sagittal saw attachment or TRS Recon Sagittal Saw vibrates too much. | Saw blade locking mechanism is not tightened or is loose. | Tighten the locking knob for the saw blade quick coupling or tighten the saw blade coupling screw by turning the key (05.001.229) clockwise. |
| Saw attachment saws too fast / too aggressively.                     | Wrong mode set (DRILL / REAM instead of SAW).             | Set correct mode (SAW) for saw attachments.                                                                                                  |
| Bone and cutting tool heat up during surgery.                        | The cutting tool is blunt.                                | Replace the cutting tool.                                                                                                                    |

For troubleshooting for the Universal Battery Charger II please consult the relevant instructions for use.  
If the recommended solutions do not work, please contact your Synthes affiliate.

## Duty Cycle

Intermittent operation type S9,  
according to IEC 60034-1



| TRS Battery Modular                           | X <sub>on</sub> | Y <sub>off</sub> | Cycles |
|-----------------------------------------------|-----------------|------------------|--------|
| Drilling, screwing,<br>Kirschner wire setting | 30 sec          | 60 sec           | 5      |
| Reaming                                       | 30 sec          | 60 sec           | 5      |
| Sawing                                        | 30 sec          | 60 sec           | 5      |
| TRS Recon Sagittal Saw                        | X <sub>on</sub> | Y <sub>off</sub> | Cycles |
| Sawing                                        | 60 sec          | 240 sec          | 5      |

Above mentioned duty cycles can be reduced due to higher loads applied and due to ambient air temperatures above 20 °C (68 °F). This needs to be taken into consideration during the planning of the surgical intervention.

Generally, electrical systems can heat up if in constant use. For this reason the handpiece and the attachments should be allowed to cool for at least the Y<sub>off</sub> time following the X<sub>on</sub> time of constant use. After 5 such cycles, the handpiece and attachment should be allowed to cool for 30 minutes. If this is observed the system will be prevented from overheating and possibly harming the patient or user. The user is responsible for the application and for turning off the system as prescribed. If longer periods of constant use are required, an additional handpiece and/or attachment should be used.

### Precautions:

- Carefully observe the above recommended duty cycles.
- Always use new cutting tools to prevent heating up of the system due to reduced cutting performance.
- Cutting tools must be cooled with irrigation liquid to prevent heat necrosis. For this purpose, irrigate manually.
- Careful maintenance of the system will reduce heat development in the handpiece and the attachments.

Technical data is subject to tolerances.



## Machine Specifications

---

### TRS Battery Modular

---

|                                                       |                                |
|-------------------------------------------------------|--------------------------------|
| Dimensions of handpiece with lid (without attachment) | 253 × 137 × 88 mm              |
| Weight of handpiece with power module and lid         | 1,300 g                        |
| Gradually adjustable speed (without attachment)       | 0–18,000 rpm (Drill/Ream mode) |
| Handpiece cannulation                                 | 4.1 mm                         |
| Protection class                                      | BF, EN 60601-1                 |
| Degree of protection                                  | IPX4, EN 60529                 |
| Power supply                                          | Internally powered             |

---

### TRS Recon Sagittal Saw

---

|                                               |                    |
|-----------------------------------------------|--------------------|
| Dimensions of handpiece with lid              | 262 × 197 × 88 mm  |
| Weight of handpiece with power module and lid | 1,760 g            |
| Gradually adjustable speed                    | 0–11,000 osc/min   |
| Protection class                              | BF, EN 60601-1     |
| Degree of protection                          | IPX4, EN 60529     |
| Power supply                                  | Internally powered |

---

### Battery







---

|                            |          |
|----------------------------|----------|
| Type                       | Li-Ion   |
| Operating voltage (normal) | 25.2 V   |
| Capacity                   | 1.2 Ah   |
| Typical charging time      | < 60 min |

---

Technical data is subject to tolerances.

## Environmental Conditions

|                      | <b>Operation</b>                                                                                                    | <b>Storage</b>                                                                                                       |
|----------------------|---------------------------------------------------------------------------------------------------------------------|----------------------------------------------------------------------------------------------------------------------|
| Temperature          | 10 °C<br>50 °F<br> 40 °C<br>104 °F | 10 °C<br>50 °F<br> 40 °C<br>104 °F |
| Relative humidity    | 30 %<br> 90 %                      | 30 %<br> 90 %                      |
| Atmospheric pressure | 500 hPa<br> 1060 hPa               | 500 hPa<br> 1060 hPa              |
| Altitude             | 0–5000 m                                                                                                            | 0–5000 m                                                                                                             |

### Transportation\*

| Temperature    | Duration | Humidity     |
|----------------|----------|--------------|
| –29 °C; –20 °F | 72 h     | uncontrolled |
| 38 °C; 100 °F  | 72 h     | 85 %         |
| 60 °C; 140 °F  | 6 h      | 30 %         |

\*products have been tested according to ISTA 2A

**Precaution:** The machine must not be stored or operated in explosive atmospheres.

## Applicable Standards

---

The device meets the following standards

Medical electrical equipment - Part 1:  
General requirements for basic safety and  
essential performance:

---

IEC 60601-1 (2012) (Ed 3.1),

---

EN 60601-1 (2006) + A11 + A1 + A12,

---

ANSI/AAMI ES60601-1:2005/(R)2012,

---

CSA CAN/CSA-C22.2 NO. 60601-1:14

---

Medical electrical equipment - Part 1-2:  
Collateral Standard: Electromagnetic disturbances -  
Requirements and tests:

---

IEC 60601-1-2 (2014) (Ed 4.0),

---

EN 60601-1-2 (2015)

---

Medical electrical equipment - Part 1-6: Collateral Standard:  
Usability:

---

IEC 60601-1-6 (2010) (Ed. 3.0) + A1 (2010)

---



Medical  
General medical equipment as to electrical shock,  
fire and mechanical hazards only in accordance  
with: ANSI/AAMI ES60601-1 (2005) + AMD 1  
(2012) CAN/CSA-C22.2 No. 60601-1 (2014)

**Declaration of the emission sound pressure level and the sound power level according to the EU Directive 2006/42/EG Annex I**

Sound pressure level [LpA] in accordance with the norm EN ISO 11202

Sound power level [LwA] in accordance with the norm EN ISO 3746

| Handpiece                                       | Attachment                                             | Tool                 | Sound Pressure Level (LpA) in [dB(A)] | Sound Power Level (LwA) in [dB(A)] | Max. daily exposure time without hearing protection |
|-------------------------------------------------|--------------------------------------------------------|----------------------|---------------------------------------|------------------------------------|-----------------------------------------------------|
| TRS Battery Modular 05.001.201 <sup>1)</sup>    | –                                                      | –                    | 72                                    | –                                  | > 8 h                                               |
| TRS Battery Modular 05.001.201 <sup>1)</sup>    | AO/ASIF Quick Coupling 05.001.205                      | –                    | 76                                    | –                                  | > 8 h                                               |
|                                                 | Sagittal Saw Attachment 05.001.223 <sup>2)</sup>       | Saw blade 519.115    | 94                                    | 104                                | 1 h                                                 |
|                                                 |                                                        | Saw blade 519.170    | 86                                    | 99                                 | 6 h 21 min                                          |
|                                                 |                                                        | Saw blade 05.002.105 | 95                                    | 105                                | 48 min                                              |
|                                                 | Sagittal Saw Attachment, long 05.001.224 <sup>3)</sup> | Saw blade 519.115    | 90                                    | 100                                | 2 h 32 min                                          |
|                                                 |                                                        | Saw blade 519.170    | 82                                    | 93                                 | > 8 h                                               |
|                                                 |                                                        | Saw blade 05.002.105 | 90                                    | 101                                | 2 h 32 min                                          |
|                                                 | Reciprocating Saw Attachment 05.001.225 <sup>4)</sup>  | Saw blade 511.905    | 88                                    | 99                                 | 4 h                                                 |
|                                                 |                                                        | Saw blade 511.912    | 89                                    | 100                                | 3 h 11 min                                          |
| TRS Recon Sagittal Saw 05.001.240 <sup>5)</sup> | –                                                      | –                    | 72                                    | –                                  | > 8 h                                               |
|                                                 |                                                        | Saw blade 519.115    | 86                                    | 95                                 | 8 h                                                 |
|                                                 |                                                        | Saw blade 519.170    | 78                                    | –                                  | > 8 h                                               |
|                                                 |                                                        | Saw blade 05.002.105 | 87                                    | 97                                 | 5 h 3 min                                           |

Operating condition:

<sup>1)</sup> Handpiece 05.001.201 in DRILL/REAM mode with 18,000 rpm

<sup>2)</sup> Handpiece 05.001.201 with Sagittal Saw Attachment 05.001.223 in SAW mode with 11,000 osc/min

<sup>3)</sup> Handpiece 05.001.201 with Sagittal Saw Attachment, long 05.001.224 in SAW mode with 11,000 osc/min

<sup>4)</sup> Handpiece 05.001.201 with Reciprocating Saw Attachment 05.001.225 in SAW mode with 11,000 osc/min

<sup>5)</sup> Handpiece 05.001.240 in SAW mode with 11,000 osc/min (vertical position)

## Declaration of vibration emissions according to EU Directive 2006/42/EG Annex 1

Vibration emissions [ $m/s^2$ ] according to EN ISO 8662.

| Handpiece                                       | Attachment                                                | Tool                                                | Declaration [ $m/s^2$ ] | Max daily exposure |
|-------------------------------------------------|-----------------------------------------------------------|-----------------------------------------------------|-------------------------|--------------------|
| TRS Battery Modular<br>05.001.201 <sup>1)</sup> | –                                                         | –                                                   | < 2.5                   | no limitation      |
| TRS Battery Modular<br>05.001.201 <sup>1)</sup> | AO/ASIF Quick Coupling<br>05.001.205                      | –                                                   | < 2.5                   | no limitation      |
|                                                 |                                                           | Sagittal Saw Attachment<br>05.001.223 <sup>2)</sup> | Saw blade 519.115       | 16.2               |
|                                                 | Saw blade 519.170                                         |                                                     | 6.7                     | 4 h 27 min         |
|                                                 | Saw blade 05.002.105                                      |                                                     | 18.3                    | 36 min             |
|                                                 | Sagittal Saw Attachment, long<br>05.001.224 <sup>3)</sup> | Saw blade 519.115                                   | 11.4                    | 1 h 32 min         |
|                                                 |                                                           | Saw blade 519.170                                   | 5.8                     | 5 h 55 min         |
|                                                 |                                                           | Saw blade 05.002.105                                | 12.5                    | 1 h 17 min         |
|                                                 | Reciprocating Saw Attachment<br>05.001.225 <sup>4)</sup>  | Saw blade 511.905                                   | 9.4                     | 2 h 15 min         |
|                                                 |                                                           | Saw blade 511.912                                   | 9.3                     | 2 h 20 min         |
|                                                 | TRS Recon Sagittal<br>Saw 05.001.240 <sup>5)</sup>        | –                                                   | –                       | > 2.5              |
|                                                 |                                                           | Saw blade 519.115                                   | 8.6                     | 2 h 44 min         |
|                                                 |                                                           | Saw blade 519.170                                   | 3.5                     | no limitation      |
|                                                 |                                                           | Saw blade 05.002.105                                | 9.7                     | 2 h 8 min          |

Operating condition:

<sup>1)</sup> Handpiece 05.001.201 in in DRILL/REAM mode with 18,000 rpm

<sup>2)</sup> Handpiece 05.001.201 with Sagittal Saw Attachment 05.001.223 in SAW mode with 11,000 osc/min

<sup>3)</sup> Handpiece 05.001.201 with Sagittal Saw Attachment, long 05.001.224 in SAW mode with 11,000 osc/min

<sup>4)</sup> Handpiece 05.001.201 with Reciprocating Saw Attachment 05.001.225 in SAW mode with 11,000 osc/min

<sup>5)</sup> Handpiece 05.001.240 in SAW mode with 11,000 osc/min

Technical data is subject to tolerances.

## Electromagnetic Compatibility Accompanying documents in accordance with IEC 60601-1-2, 2014, ed. 4.0

**Table 1: Emissions**

### ***Guidelines and manufacturer's declaration – electromagnetic emissions***

The Synthes TRS handpiece is intended for use in the electromagnetic environment specified below.  
The customer or the user of the Synthes TRS handpiece should assure that it is used in such an environment.

| <b><i>Emission test</i></b>                                 | <b><i>Compliance</i></b> | <b><i>Electromagnetic environment – guidance</i></b>                                                                                                                                           |
|-------------------------------------------------------------|--------------------------|------------------------------------------------------------------------------------------------------------------------------------------------------------------------------------------------|
| RF emissions<br>CISPR 11                                    | Group 1                  | The Synthes TRS handpiece uses RF energy only for its internal function. Therefore, its RF emission is very low and it is not likely to cause any interference in nearby electronic equipment. |
| RF emissions<br>CISPR 11                                    | Class B                  | The TRS System is suitable for use in professional healthcare facility environment but not in home healthcare or special environment.                                                          |
| Harmonic emissions<br>IEC 61000-3-2                         | Not applicable           |                                                                                                                                                                                                |
| Voltage fluctuations/<br>flicker emissions<br>IEC 61000-3-3 | Not applicable           |                                                                                                                                                                                                |

**Table 2: Immunity (all devices)****Guidelines and manufacturer's declaration – electromagnetic immunity**

The Synthes TRS handpiece is intended for use in the electromagnetic environment specified below.  
The customer or the user of the Synthes TRS handpiece should assure that it is used in such an environment.

| <b>Immunity test standard</b>                                                                    | <b>IEC 60601 test level</b>                                                                 | <b>Compliance level</b>     | <b>Electromagnetic environment – guidance</b>                                                                                                      |
|--------------------------------------------------------------------------------------------------|---------------------------------------------------------------------------------------------|-----------------------------|----------------------------------------------------------------------------------------------------------------------------------------------------|
| Electrostatic discharge (ESD)<br>IEC 61000-4-2                                                   | ±8 kV contact<br>±15 kV air                                                                 | ±8 kV contact<br>±15 kV air | Floors should be wood, concrete or ceramic tile.<br>If floors are covered with a synthetic material, the relative humidity should be at least 30%. |
| Electrical fast transient/burst<br>IEC 61000-4-4                                                 | ±2 kV for power supply lines<br>±1 kV for signal lines                                      | Not applicable              | Mains power quality should be that of a typical commercial or hospital environment.                                                                |
| Surge<br>IEC 61000-4-5                                                                           | ±1 kV line to line<br>±2 kV line to earth                                                   | Not applicable              | Mains power quality should be that of a typical commercial or hospital environment.                                                                |
| Voltage dips, short interruptions and voltage variations on power supply lines<br>IEC 61000-4-11 | <5% $U_T$ (0.5 cycle)<br>40% $U_T$ (5 cycles)<br>70% $U_T$ (25 cycles)<br><5% $U_T$ for 5 s | Not applicable              | Mains power quality should be that of a typical commercial or hospital environment.                                                                |
| Power frequency (50/60 Hz) magnetic field<br>IEC 61000-4-8                                       | 30 A/m                                                                                      | 200 A/m                     | Power frequency magnetic fields should be at levels characteristic of a typical location in a typical commercial or hospital environment.          |

**Note:**  $U_T$  is the a.c. mains voltage prior to application of the test level.

**Table 3: Immunity (not life-supporting devices)**

**Guidance and manufacturer's declaration – electromagnetic immunity**

The Synthes TRS handpiece is intended for use in the electromagnetic environment specified below. The customer or the user of the Synthes TRS handpiece should assure that it is used in such an environment.

**Precaution**

Use of this equipment adjacent to or stacked with other equipment should be avoided because it could result in improper operation. If such use is necessary, this equipment and the other equipment should be observed to verify that they are operating normally.

**Electromagnetic environment – guidance**

Portable and mobile RF communications equipment should be used no closer to any part of the Synthes TRS handpiece, including cables, than the recommended separation distance calculated from the equation applicable to the frequency of the transmitter.

| <b>Immunity test standard</b> | <b>IEC 60601 test level</b> | <b>Compliance level</b>           | <b>Recommended separation distance</b>   |
|-------------------------------|-----------------------------|-----------------------------------|------------------------------------------|
| Conducted RF<br>IEC 61000-4-6 | 3 Vrms<br>150 kHz to 80 MHz | Not applicable                    | $d = 0.35 \sqrt{P}$<br>150 kHz to 80 MHz |
| Radiated RF<br>IEC 61000-4-3  | 3 V/m<br>80 MHz to 800 MHz  | E1 = 10 V/m<br>80 MHz to 800 MHz  | $d = 0.35 \sqrt{P}$<br>80 MHz to 800 MHz |
| Radiated RF<br>IEC 61000-4-3  | 3 V/m<br>800 MHz to 2.7 GHz | E2 = 10 V/m<br>800 MHz to 2.7 GHz | $d = 0.7 \sqrt{P}$<br>800 MHz to 6.2 GHz |

where  $P$  is the maximum output power rating of the transmitter in watts (W) according to the transmitter manufacturer and  $d$  is the recommended separation distance in metres (m).

Field strengths from fixed RF transmitters as determined by an electromagnetic site survey,<sup>a</sup> should be less than the compliance level in each frequency range.<sup>b</sup>



Interference may occur in the vicinity of equipment marked with the following symbol:

**Note 1:** At 80 MHz and 800 MHz, the higher frequency range applies.

**Note 2:** These guidelines may not apply in all situations. Electromagnetic propagation is affected by absorption and reflection from structures, objects and people.

<sup>a</sup> Field strengths from fixed transmitters, such as base stations for radio (cellular/cordless) telephones and land mobile radios, amateur radio, AM and FM radio broadcast and TV broadcast cannot be predicted theoretically with accuracy. To assess the electromagnetic environment due to fixed RF transmitters, an electromagnetic site survey should be considered. If the measured field strength in the location in which the Synthes TRS handpiece is used exceeds the applicable RF compliance level above, the Synthes TRS handpiece should be observed to verify normal operation. If abnormal performance is observed, additional measures may be necessary, such as re-orienting or relocating the Synthes TRS handpiece.

<sup>b</sup> Over the frequency range 150 kHz to 80 MHz, field strengths should be less than 3 V/m.



**Table 4: Recommended separation distances (not life-supporting devices)**

**Recommended separation distances between portable and mobile RF communications equipment and the Synthes TRS handpiece**

The Synthes TRS handpiece is intended for use in the electromagnetic environment in which radiated RF disturbances are controlled. The customer or the user of the Synthes TRS handpiece can help prevent electromagnetic interference by maintaining a minimum distance between portable and mobile RF communications equipment (transmitters) and the Synthes TRS handpiece as recommended below, according to the maximum output power of the communication equipment.

| Rated maximum output power of transmitter<br>W | Separation distance according to frequency of transmitter |                                          |                                         |
|------------------------------------------------|-----------------------------------------------------------|------------------------------------------|-----------------------------------------|
|                                                | 150 kHz to 80 MHz<br>$d = 0.35 \sqrt{P}$                  | 80 MHz to 800 MHz<br>$d = 0.35 \sqrt{P}$ | 800 MHz to 6.2GHz<br>$d = 0.7 \sqrt{P}$ |
| 0.01                                           | 3.5 cm                                                    | 3.5 cm                                   | 7 cm                                    |
| 0.1                                            | 12 cm                                                     | 12 cm                                    | 22 cm                                   |
| 1                                              | 35 cm                                                     | 35 cm                                    | 70 cm                                   |
| 10                                             | 1.2 m                                                     | 1.2 m                                    | 2.2 m                                   |
| 100                                            | 3.5 m                                                     | 3.5 m                                    | 7 m                                     |

For transmitters rated at a maximum output power not listed above, the recommended separation distance  $d$  in metres (m) can be estimated using the equation applicable to the frequency of the transmitter, where  $P$  is the maximum output power rating of the transmitter in watts (W) according to the transmitter manufacturer.

**Note 1:** At 80 MHz and 800 MHz, the separation distance for the higher frequency range applies.

**Note 2:** These guidelines may not apply in all situations. Electromagnetic propagation is affected by absorption and reflection from structures, objects and people.

# Ordering Information

## Trauma Recon System set content (modular)

|            |                                                                                                            |
|------------|------------------------------------------------------------------------------------------------------------|
| 01.001.590 | Set Trauma Recon System (modular)                                                                          |
| 05.001.201 | Battery Handpiece, modular, for Trauma Recon System                                                        |
| 05.001.202 | Power Module, for Trauma Recon System, (2 per set)                                                         |
| 05.001.203 | Sterile Cover, for Trauma Recon System                                                                     |
| 05.001.231 | Lid for No. 05.001.201 (modular), for Trauma Recon System                                                  |
| 05.001.205 | AO/ASIF Quick Coupling, for Trauma Recon System                                                            |
| 05.001.206 | Drill Chuck (drilling speed), with Key, for Trauma Recon System, clamping range up to $\varnothing$ 7.3 mm |
| 05.001.210 | Attachment for Acetabular and Medullary Reaming, for Trauma Recon System                                   |
| 05.001.212 | Quick Coupling for Kirschner Wires $\varnothing$ 1.0 to 4.0 mm, for Trauma Recon System                    |
| 05.001.213 | Quick Coupling for DHS/DCS <sup>®</sup> Triple Reamers, for Trauma Recon System                            |
| 05.001.214 | Screw Attachment, with AO/ASIF Quick Coupling, for Trauma Recon System                                     |
| 05.001.224 | Sagittal Saw Attachment, long, with T-Handle, for Trauma Recon System                                      |
| 68.001.606 | Washing Basket, Full Size 1/1, for Trauma Recon System                                                     |
| 68.001.602 | Lid for Washing Basket, Full Size 1/1                                                                      |

## Trauma Recon System set content (Recon Sagittal Saw)

|            |                                                                               |
|------------|-------------------------------------------------------------------------------|
| 01.001.591 | Set Trauma Recon System (Recon Sagittal Saw)                                  |
| 05.001.240 | Battery Handpiece, Recon Sagittal Saw, with T-handle, for Trauma Recon System |
| 05.001.241 | Lid for No. 05.001.240 (Recon Saw), for Trauma Recon System                   |
| 05.001.202 | Power Module, for Trauma Recon System                                         |
| 05.001.203 | Sterile Cover, for Trauma Recon System                                        |

## Power Tools

|            |                                                                               |
|------------|-------------------------------------------------------------------------------|
| 05.001.201 | Battery Handpiece, modular, for Trauma Recon System                           |
| 05.001.231 | Lid for No. 05.001.201 (modular), for Trauma Recon System                     |
| 05.001.240 | Battery Handpiece, Recon Sagittal Saw, with T-Handle, for Trauma Recon System |
| 05.001.241 | Lid for No. 05.001.240 (Recon Saw), for Trauma Recon System                   |

## Charger, battery and accessories for battery

|            |                                        |
|------------|----------------------------------------|
| 05.001.204 | Universal Battery Charger II           |
| 05.001.202 | Power Module, for Trauma Recon System  |
| 05.001.203 | Sterile Cover, for Trauma Recon System |

## Attachments for TRS Battery Modular

|            |                                                                                                            |
|------------|------------------------------------------------------------------------------------------------------------|
| 05.001.205 | AO/ASIF Quick Coupling, for Trauma Recon System                                                            |
| 05.001.206 | Drill Chuck (drilling speed), with key, for Trauma Recon System, clamping range up to $\varnothing$ 7.3 mm |
| 05.001.207 | Drill Chuck (reaming speed), with key, for Trauma Recon System, clamping range up to $\varnothing$ 7.3 mm  |
| 05.001.208 | Drill Chuck, keyless, for Trauma Recon System                                                              |
| 05.001.210 | Attachment for Acetabular and Medullary Reaming, for Trauma Recon System                                   |
| 05.001.212 | Quick Coupling for Kirschner Wires $\varnothing$ 1.0 to 4.0 mm, for Trauma Recon System                    |
| 05.001.213 | Quick Coupling for DHS/DCS <sup>®</sup> Triple Reamers, for Trauma Recon System                            |
| 05.001.214 | Screw Attachment, with AO/ASIF Quick Coupling, for Trauma Recon System                                     |
| 05.001.215 | Torque Limiter, 1.5 Nm, for Trauma Recon System                                                            |
| 05.001.216 | Torque Limiter, 4.0 Nm, for Trauma Recon System                                                            |
| 05.001.217 | Hudson Quick Coupling (drilling speed), for Trauma Recon System                                            |
| 05.001.218 | Hudson Quick Coupling (reaming speed), for Trauma Recon System                                             |
| 05.001.219 | Trinkle Quick Coupling (drilling speed), for Trauma Recon System                                           |
| 05.001.220 | Trinkle Quick Coupling (reaming speed), for Trauma Recon System                                            |
| 05.001.221 | Trinkle Quick Coupling (drilling speed), modified, for Trauma Recon System                                 |
| 05.001.222 | Trinkle Quick Coupling (reaming speed), modified, for Trauma Recon System                                  |
| 05.001.223 | Sagittal Saw Attachment, for Trauma Recon System                                                           |
| 05.001.224 | Sagittal Saw Attachment, long, with T-Handle, for Trauma Recon System                                      |
| 05.001.225 | Reciprocating Saw Attachment, for Trauma Recon System                                                      |
| 05.001.226 | Adapter for Radiolucent Drive, for Trauma Recon System                                                     |
| 511.904    | Top for Sternum for Reciprocating Saw Attachment                                                           |
| 511.300    | Radiolucent Drive                                                                                          |
| 510.200    | Angular Drive Unit for Medullary Reaming                                                                   |
| 511.787    | Kuentscher Adapter                                                                                         |
| 511.788    | Harris Adapter                                                                                             |

## Accessories

|            |                                                                      |
|------------|----------------------------------------------------------------------|
| 510.191    | Spare Key for Drill Chuck, clamping range up to $\varnothing$ 7.3 mm |
| 516.101    | Cleaning brush                                                       |
| 519.970    | Oil Dispenser with Synthes Special Oil, 40 ml                        |
| 05.001.229 | T-Handle for fixing of saw blades                                    |

---

**Vario Cases and Washing Baskets**

|            |                                                                                                |
|------------|------------------------------------------------------------------------------------------------|
| 68.001.595 | Vario Case, size 1/1, for Trauma Recon System with two Inserts, without Lid, without Contents  |
| 68.001.592 | Vario Case, size 1/2, for Trauma Recon System Battery Handpiece, without Lid, without Contents |
| 689.507    | Lid (Stainless Steel), size 1/1, for Vario Case                                                |
| 689.537    | Lid (Stainless Steel), size 1/2, for Vario Case                                                |
| 68.001.606 | Washing Basket, Full Size 1/1, for Trauma Recon System                                         |
| 68.001.602 | Lid for Washing Basket, Full Size 1/1                                                          |
| 68.001.603 | Washing Basket, size 1/2, for Trauma Recon System                                              |
| 68.001.604 | Lid for Washing Basket, size 1/2                                                               |

For further information please contact your local Synthes representative.

**Cutting tools**

Detailed ordering information on the saw blades for the TRS system can be found in the brochure "Saw Blades" (036.001.681).

Detailed ordering information on the special 3-flute drill bits for the Radiolucent Drive can be found in the brochure "Working with the Radiolucent Drive" (036.000.150).

